

# Service Service Service

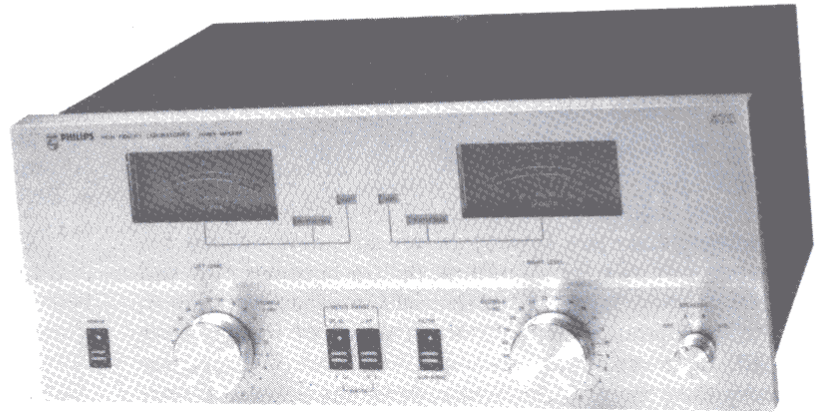

## Part 1

15862A

# Circuit Description

### TECHNICAL DATA

Continuous power	: 210 Watts/Channel	Signal to noise ratio	: 100 dB
Band	: 20-20,000 Hz	Input sensitivity	: 1 Volt
Total harmonic distortion	: 0.08 %	Rated impedance	: 50K $\Omega$
Load	: 8 $\Omega$	Sub-Sonic filter, at 10 Hz	: 12 dB/Octave
IM distortion, at rated power	: 0.08 %	Inputs	: 2
Distortion, at 2 watts		Speaker terminals	: 2 sets
THD	: 0.02 %	Power supply	: 120/220 V 50/60 Hz
IM (SMPTE 4:1)	: 0.02 %	Power consumption, at 10 % rated output	: 780 Watts
Continuous power at 1,000 Hz, .08 % THD	: 250 Watts/Channel	Dimensions	: 200x457x381 mm
Frequency response, $\pm$ 0.5 dB	: 10-30,000 Hz	Weight	: 28.6 kg
Separation, at 1,000 Hz	: 60 dB		
Damping factor at 8 $\Omega$ load	: 90		

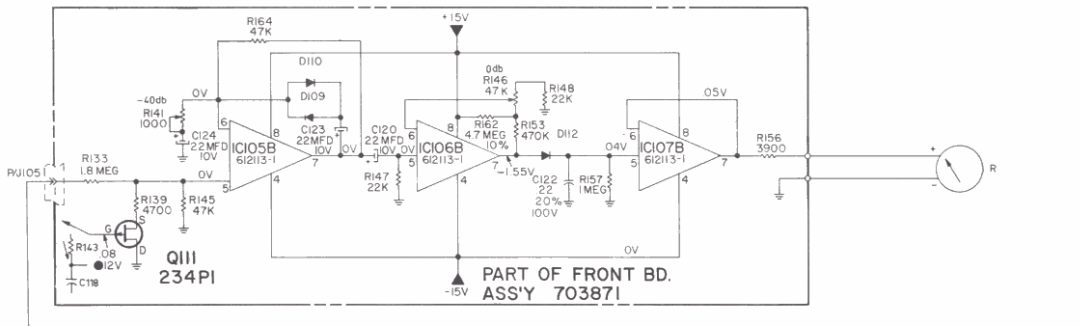
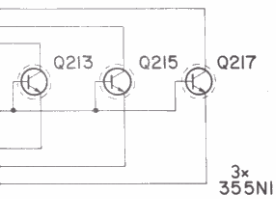
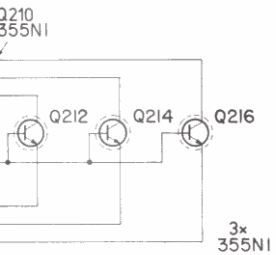
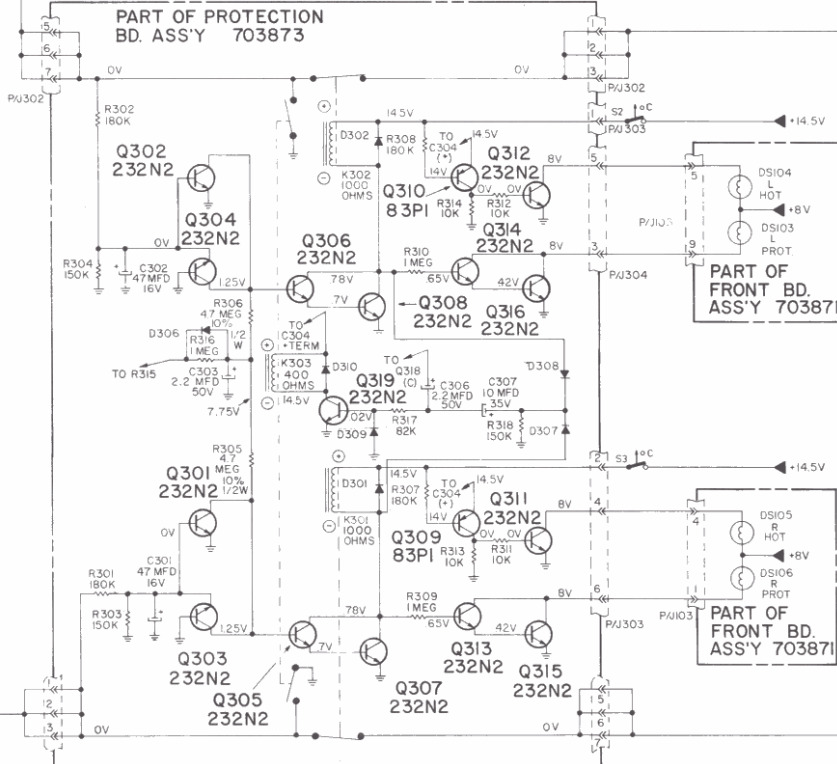
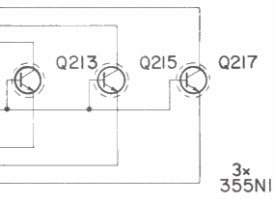
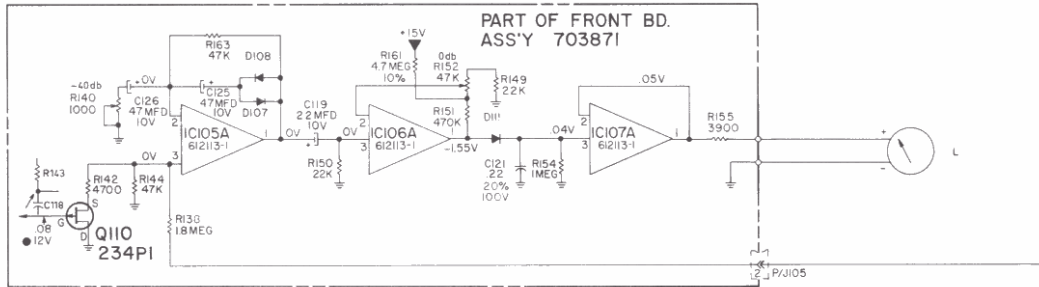
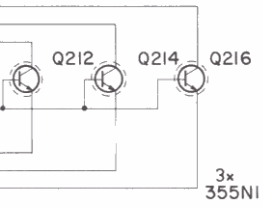

The gain of IC106 is controlled by the feedback from a network consisting of R151, R152 and R149, which is applied to the inverting input (pin 2).

The output of IC106 (pin 1) is half-wave rectified by D111 and applied to the "sample and hold" circuit comprised of C121, R154 and D111. The "sample and hold" circuit is used to increase the duration of the DC level applied to the input of IC107 (pin 3). This action damps the level meter indication for more accurate readings. The design of the circuit allows C121 to charge quickly and discharge slowly. C121 constantly charges and discharges

with reference to the audio signal.

The voltage developed by C121 is applied to the input of IC107 (pin 3). IC107 functions as a voltage follower and offers a high input impedance for minimum loading of the input signal, while its low output impedance is required to drive the level meter. The signal at the output of IC107 (pin 1) is coupled directly to the inverting input (pin 2). This feedback insures IC107 operates with a gain of unity. Simultaneously, the output of IC107 (pin 1) is applied through R155 to the positive terminal of the level meter, which indicates the instantaneous peak power applied to the speaker.

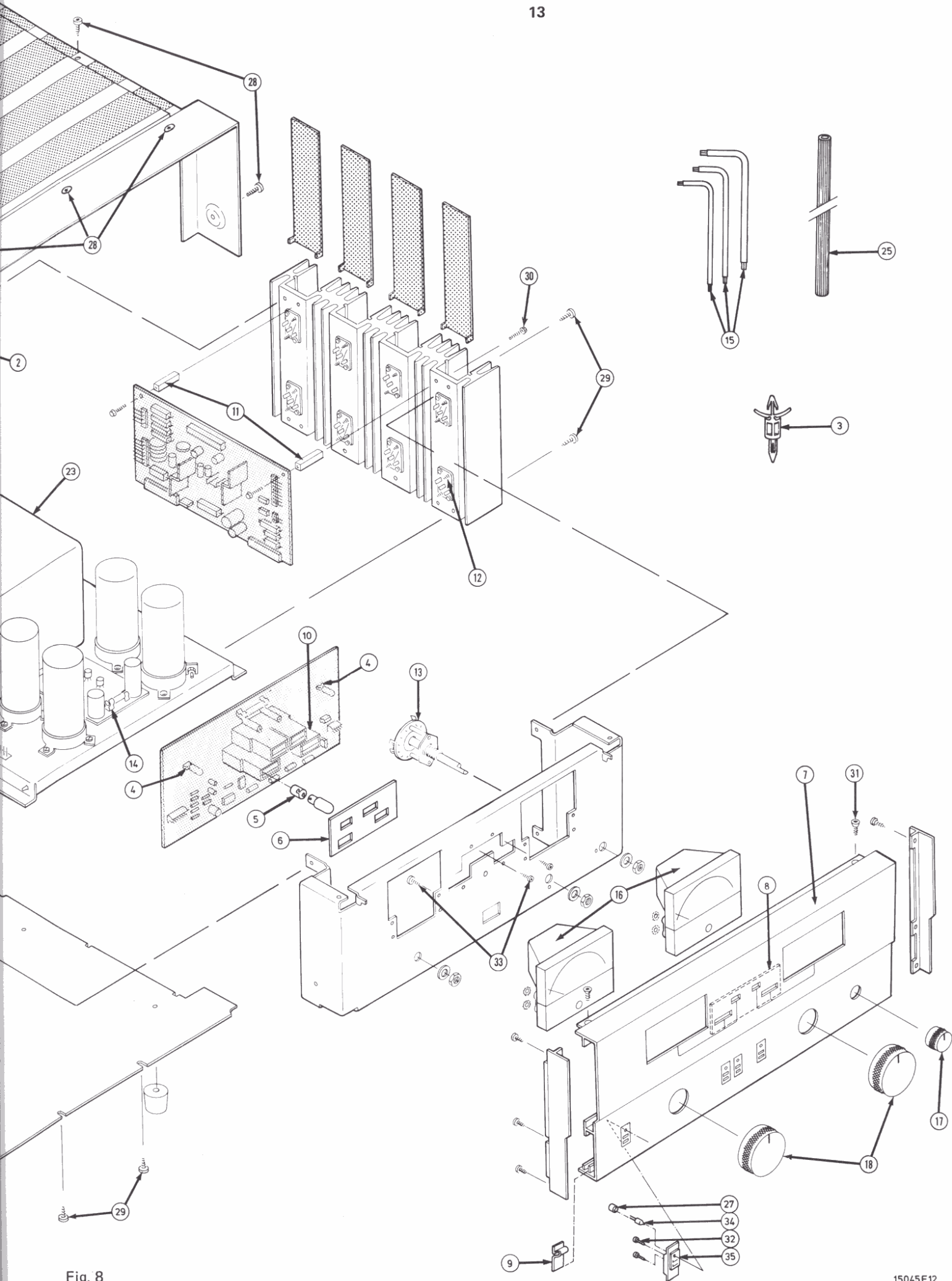
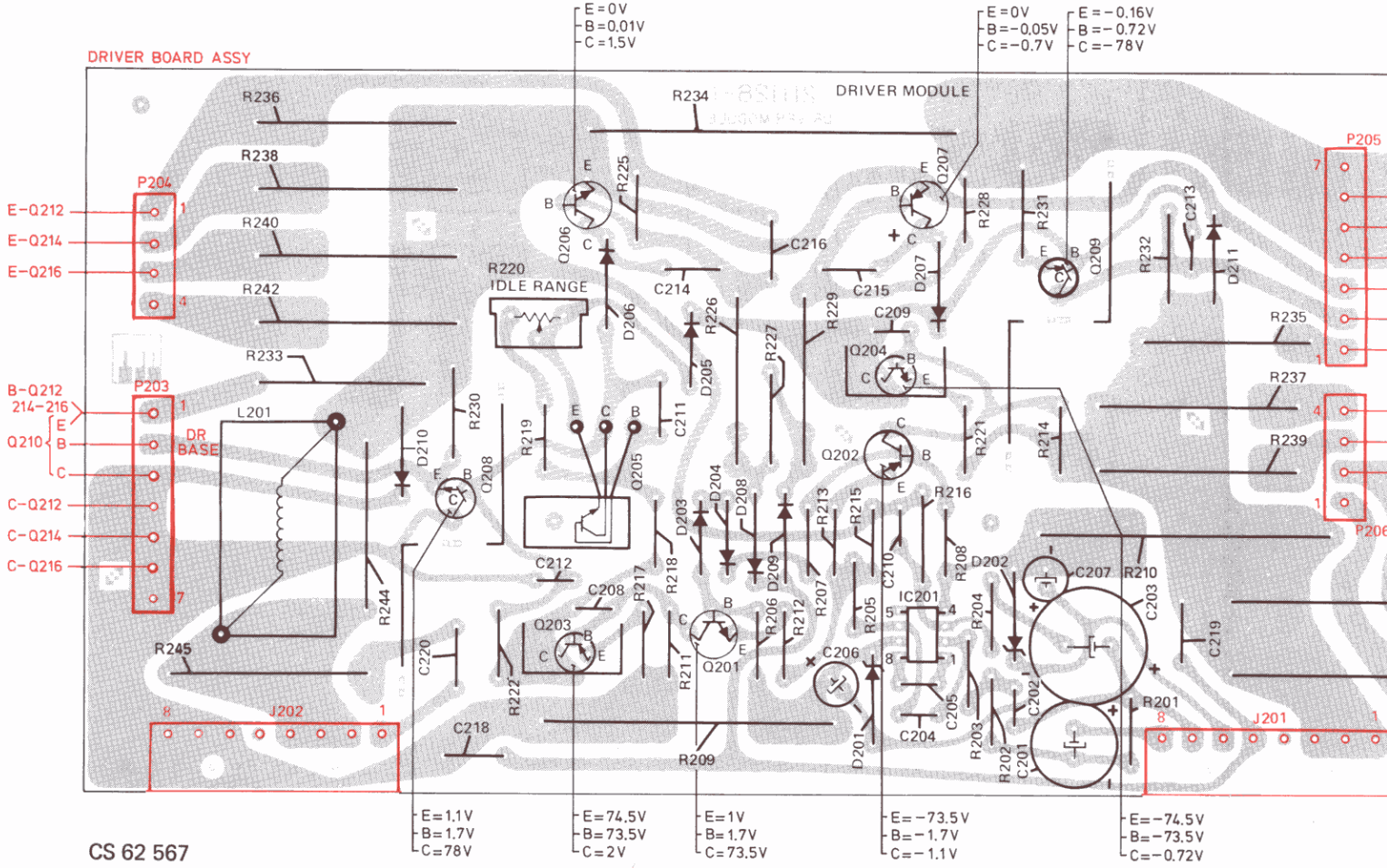
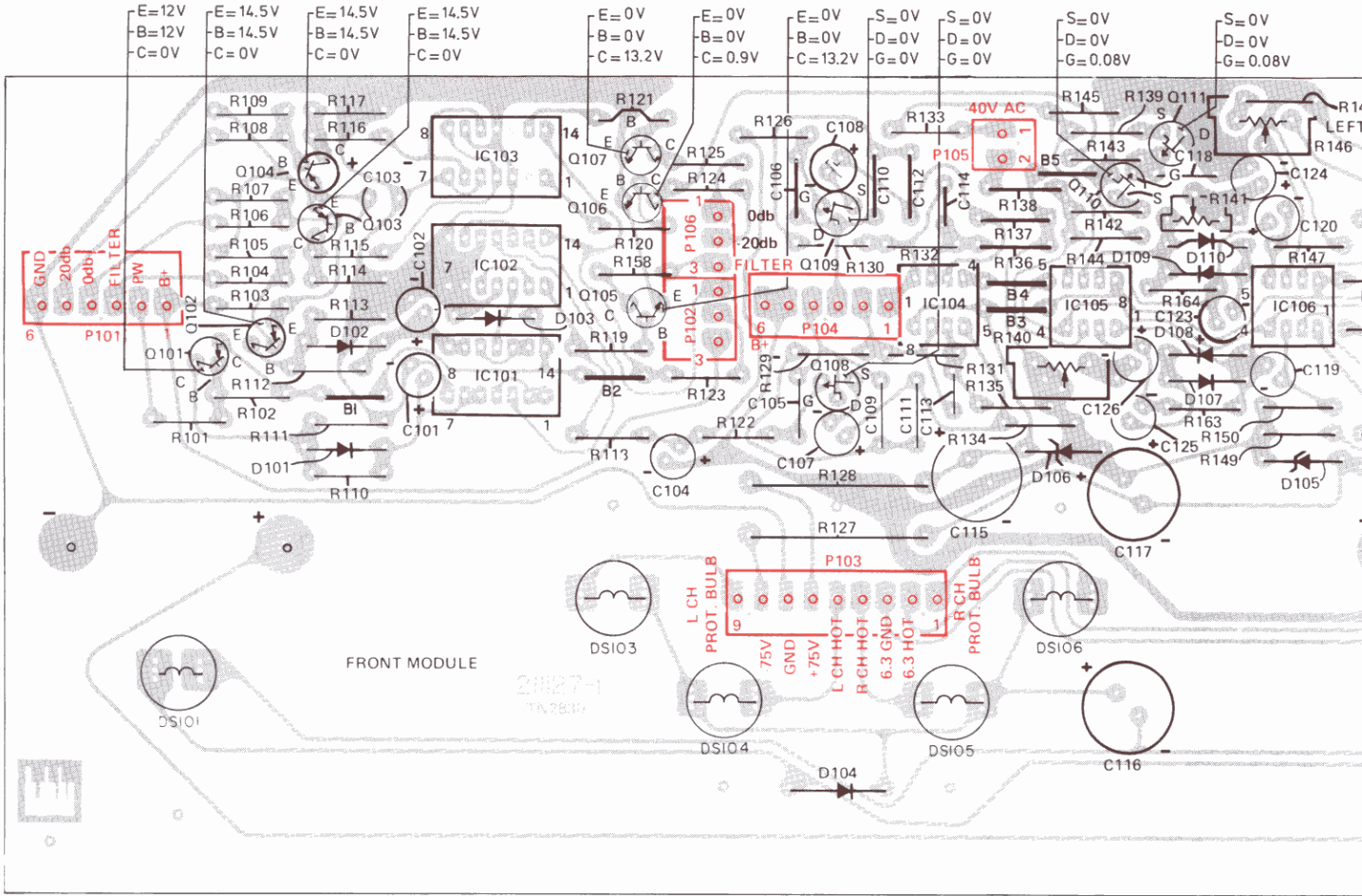
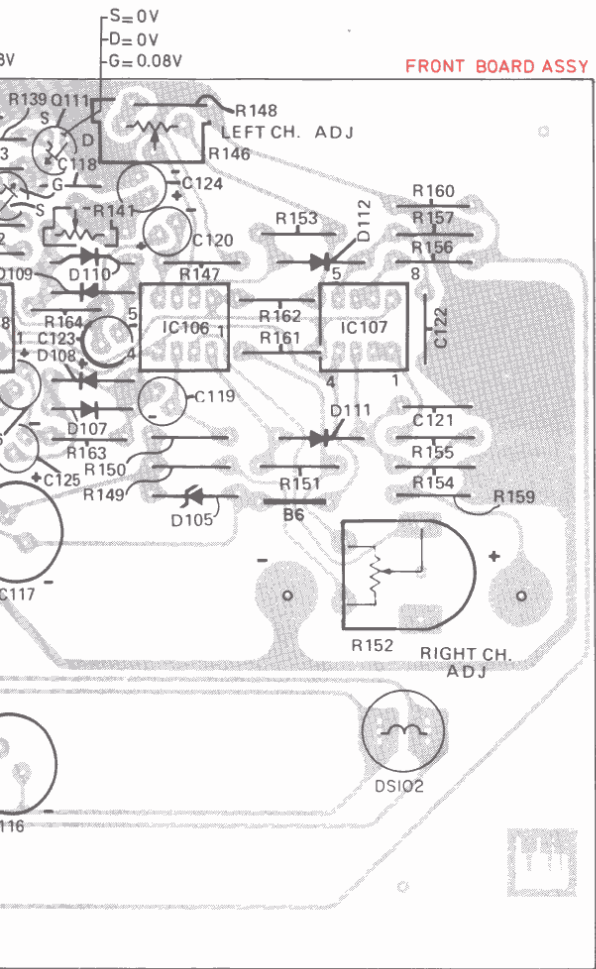

Fig. 8









TOUCH CONTROL BOARD ASSY

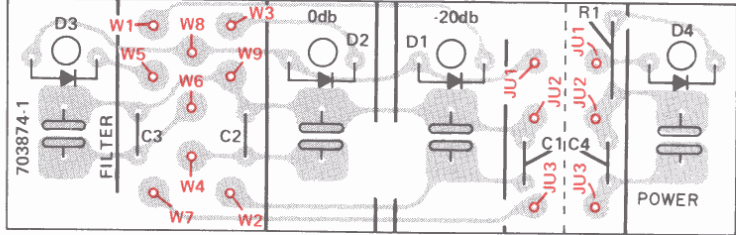

	E	B	C
Q301	0V	0V	1.25V
Q302	0V	0V	1.25V
Q303	16V	0V	1.25V
Q304	0V	0V	1.25V
Q305	0.7V	1.25V	0.78V
Q306	0.7V	1.25V	0.78V
Q307	0V	0.7V	0.78V
Q308	0V	0.7V	0.78V
Q309	14.5V	14V	0V
Q310	14.5V	14V	0V
Q311	0V	0V	8V
Q312	0V	0V	8V
Q313	0.42V	0.65V	8V
Q314	0.42V	0.65V	8V
Q315	0V	0.42V	8V
Q316	0V	0.42V	8V
Q317	0.9V	1.6V	0.9V
Q318	0V	0.9V	0.9V

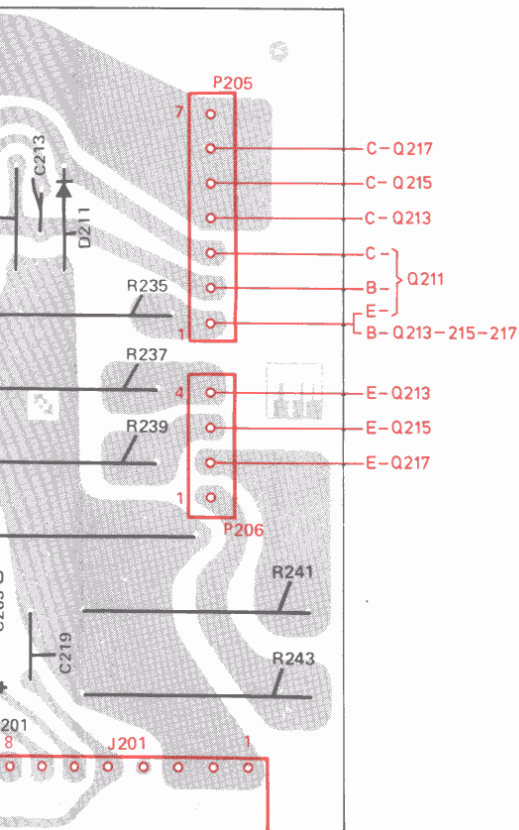

PROTECTION BOARD ASSY

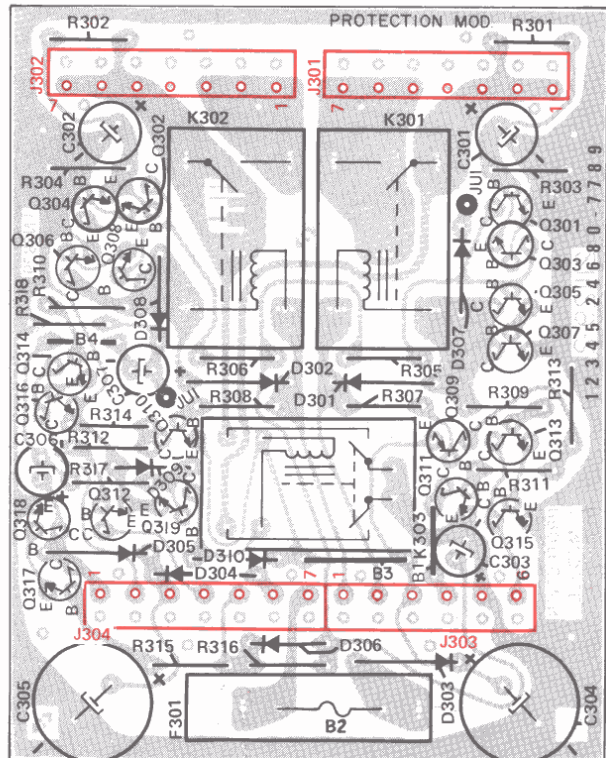

Fig. 6



## Power Supply

The Power Supply section develops the DC voltage sources needed by the individual circuits, as well as the 6.3 VAC needed by the level meter pilot lamps. The Power Supply is located in three different areas of the chassis.

Components developing the pair of +78 V and -78 V sources are located on the chassis pan. One set of +78 V and -78 V sources supply power to the left channel Driver Board assembly, and heat sink mounted driver and output transistors; while the other set of +78 V and -78V sources supply power to the right channel Driver Board assembly, and heat sink mounted driver and output transistors.

Located on the Front Board assembly are the +15 V, -15 V, +12 V and +8 V sources. The +15 V and -15 V sources are derived from the right channel +78 V and -78 V sources and supply power to Op Amps IC104, 105, 106 and 107. The +12 V source supplies power to the Nand Gates, flip-flops and darlington switch Q101. The +8 V source supplies power to the left and right channel "Hot" and "Protection" indicator lamps.

The +14.5 V source located on the Protection Board Assembly supplies power to the protection circuit, the indicator LED's and darlington switches with the exception of Q101.

The +12 V source is present whenever the unit is plugged into a wall outlet and the Master Power switch, S11, is in the "On" position. The other sources are developed only when the front panel mounted Power Touch Control is activated along with the Master Power switch.

This arrangement allows the unit (Master Power switch "On") to be kept switched on and off with the Power Touch Control without changing the states of the flip-flops in the Touch Control circuit. Therefore, when the unit is switched off and on by the Power Touch Control, those functions that were activated when the unit was switched off, will still be activated when the unit is switched back on.

The following is a description of the operation of the Power Supply circuits. When the unit is plugged into a wall outlet, and the Master Power switch is turned to the On position, mains supply is applied to the primary of T12 where it is stepped down to a low AC voltage at the secondary. This voltage from the secondary is coupled to the Protection Board assembly at pin 6 of P/J304 where it is half wave rectified by D304 and filtered by C305. The DC voltage at the positive side of C305 serves two purposes: it is coupled off the board at pin 2 of P/J304 to supply power to the Primary Power Relay, K11, and its associated switching circuitry; it is also applied to the Front Board assembly at pin 2 of P/J102 where it is applied through R123 to zener diode D103 to develop the regulated +12 V source.

This +12 V source is applied to the Nand Gates located in IC101, the flip-flops located in IC102 and IC103, the emitter of Q101, and to the base of Q101 through R102. Since the open Power Touch Control does not allow base current in Q101, the transistor is cut-off.

When the Power Touch Control is activated, it causes the DC level at pin 13 of IC102 to rise to approximately +12 V (for a more detailed description of the Power Touch Control circuitry, see "Touch Control Circuit"). This DC voltage is coupled to the Protection Board

assembly via pin 4 of P/J304, and applied through R315 to the base of Q317. This action allows the darlington switch consisting of Q317 and Q318 to saturate (close), providing ground at Q318 collector for the make-contact Primary Power Relay K11.

When the Primary Power Relay, K11, energizes it closes its normally open contacts and allows mains supply to be applied directly to the switched outlet; and to the Power Transformer, T11, through current limiting resistor R12.

Initially, mains supply is supplied to the Power Transformer, T11, through R12. R12 limits the initial current surge drawn by the Power Transformer. Current also flows through R11, D11, and the windings of the In Rush Limiting Relay, K12. D11 half-wave rectifies the AC voltage, and charges the positive terminal of C12. The amount of time required for C11 to charge to the DC voltage necessary to energize the In Rush Limiting Relay, K12, is determined by the RC time constant of R11 and C11. When the In Rush Limiting Relay, K12, energizes; the initial current surge is over and surge current regulation to the Power Transformer is no longer required, current flow to the Power Transformer is through the contacts of K12, bypassing R11 and C11.

The stepped-down AC voltages present at the secondary windings of T11 are used to develop the switched sources. Two parallel full-wave bridge rectifiers are connected to the main secondary winding, with its center-tap grounded. BR11 develops the left channel +78 V and -78 V filtered sources; while BR12 develops the right channel +78 V and -78 V filtered sources. Another secondary winding is coupled to the Protection Board assembly via pin 5 of P/J303 where it is grounded, and pin 7 of P/J303 where it is half-wave rectified by D303 and filtered by C304 to produce the +14.5 V source. The remaining secondary winding is grounded at one end, while the other end is applied to the Front Board Assembly via pin 2 of P/J303 for AC supply to the pilot lamps used to illuminate the level meters. This 6.3 VAC is also applied to D104 and filtered by C116 to produce the +8 V source.

The +15 V source is developed by coupling the right channel +78 V source to the Front Board assembly via pin 6 of P/J303 where it is applied through R128 to zener diode D106 and filtered by C115 to produce a regulated +15 V source. The right channel -78 V source is applied to the Front Board assembly via pin 8 of P/J103 through R127 to zener diode D105 and filtered by C117 to produce a regulated -15 V source.

## Touch Control Circuit

The Touch Control circuits are located on the Touch Control Board and Front Board assembly and act as a switching network for all of the front panel touch-controls. For the following circuit descriptions, assume the Master Power switch is On.

**Power** – In this circuit Q101 represents the switch used to turn On the power for the amplifier. As with any switch, Q101 is either open (cut-off) or closed (saturated). The purpose of the Touch Control logic circuits is to make it possible to change the conduction of the switching transistor, Q101, by means of a touch-control. The main components used to perform this function are: Q101, which acts as a momentary switch; IC101, four Schmitt trigger nand gates which are externally connected to perform as two and gates; and IC102, a dual flip-flop. The +12 V source is used by the components in this circuit to maintain the state of the logic when the unit is

switched off, as explained in the Power Supply section. The +12 V source also supplies power to Q101, which will keep the Power Touch Control ready to activate the On/Off function. The inputs to each nand gate are tied together so that when they receive a high potential (about 12 V), the output of the nand gates will go high (about 12 V). Under all other conditions the output of the nand gate is low, (near ground). The flip-flop is connected so that the state of its output (high or low) is reversed each time it receives a high input.

When the Power circuit is not activated, Q101 is turned off because of the open touch-control in its base circuit. The input to IC101, (Pins 5 and 6); output of IC101, (Pin 3); input to IC102 (Pin 11); and output of IC102, (Pin 13) are all low, near ground potential. The output of IC102 is coupled to the Protection Board assembly, via pin 4 of P/J304, and is applied to the base of Q317 through R315. Q317 and Q318 are connected in a darlington configuration and function as a switch. As with any switch, Q317 and Q318 are either open (cut-off) or closed (saturated). At this time the low potential (near ground) at the output of IC102 (pin 13) is not sufficient to forward bias Q317. With no current flowing through Q317, no forward bias is developed across the emitter-base junction of Q318. With Q317 and Q318 cut-off (open), no ground is provided for the Primary Power relay (K11), and the amplifier remains switched off. Therefore, there is no +14.5 V source applied to D4, the Power indicator and it remains unlit, indicating the power is not activated.

By contacting the Power touch-control, a bias network consisting of R101, R102 and the resistance of the finger tip is formed for Q101. The transistor becomes turned on and current flow through the transistor allows a high potential (about 12 V) to be developed across R111. This high potential at the collector of Q101 is coupled through the "de-bounce" circuit, consisting of; D101, R110 and C101, to the input of IC101 (pins 5 and 6). The "de-bounce" circuit is designed to keep the switching circuit from being activated twice when firm contact with the touch-control is not made. By "brushing" over the touch-control, Q101 may be rapidly turned on and off several times. The "de-bounce" circuit integrates the rapid changes in the Q101 collector voltage caused by this condition, and applies a more constant potential to the input of IC101, causing it to change states only once.

When the inputs to IC101 go high (about 12 V), the output (pin 3) also goes high. The high potential is directly coupled to the input (pin 11) of IC102, causing its output (pin 13) to change states. Since the output was low (near ground), it now becomes high and remains there until IC102 receives another high input. The high output (about 12 V) at pin 13 of IC101 is now of sufficient amplitude to forward bias A317. With current flowing through Q317, forward bias is developed across the emitter base junction of Q318. Q317 and Q318 saturate (close), providing a ground for Primary Power relay, K11. Primary Power relay K11 energizes and closes its normally open contacts, allowing power to be applied to the amplifier (for a more detailed description of the Power Supply circuitry, see "Power Supply"). With the amplifier switched on, the +14.5 V source is applied to the anode of D4, while the cathode of D4 is tied to ground. This action causes the LED, D4, to illuminate, indicating Power has been activated.

When the finger tip is removed from the touch-control,

Q101 returns to cut-off, the input to IC101 (pins 5 and 6) returns to a low state, and the output of IC101 (pin 3) returns to its low state. Since the output of the flip-flop, IC102, changes states only when its input goes high, the new conditions will have no effect upon it. Therefore, pin 13 of IC102 will remain high, keeping the darlington pair formed by Q317 and Q318 saturated (closed), which provides a ground for Primary Power relay K11.

By contacting the touch-control a second time, another high input is applied to IC102 reversing the state of its output to a low potential (near ground). This action removes the forward bias to the darlington pair formed by Q317 and Q318. Q317 and Q318 now cut-off (open), removing the ground from Primary Power relay K11. The Primary Power relay (K11) de-energizes, opening its normally open contacts and removing power from the amplifier. When power is removed from the amplifier the +14.5 V source present at the anode of the Power LED indicator, D4, is no longer present. The Power LED indicator, D4, therefore, stops conducting and extinguished, indicating that Power has been deactivated.

*Sub-Sonic Filter* — In this circuit Q102 represents the switch used to activate the Sub-Sonic filter. As with any switch, Q102 is either open (cut-off) or closed (saturated). The purpose of the Touch Control logic circuits is to make it possible to change the condition of the switching transistor, Q102, by means of a touch-control. The main components used to perform this function are; Q102, which acts as a momentary switch; IC101, four Schmitt trigger nand gates which are externally connected to perform as two and gates; and IC102, a dual flip-flop. In this circuit the +12 V source supplies power to IC101 and IC102 to maintain the state of the logic when the unit is switched off, as explained in the Power Supply section. The +14.5 V source supplies power to Q102. The inputs to each nand gate are tied together so that when they receive a high potential (about 14 V), the output of the nand gates will go high (about 12 V). Under all other conditions the output of the nand gate is low, (near ground). The flip-flop is connected so that the state of its output (high or low) is reversed each time it receives a high input.

When the Sub-Sonic filter circuit is not activated, Q102 is turned off because of the open touch-control in its base circuit. The input to IC101, (pins 8 and 9); output of IC101, (pin 11); and input to IC102, (pin 3) are all low, near ground potential. The output of IC102 (pin 1) is low, and keeps Q105 cut-off. With Q105 cut-off there is no current path for D3, the Sub-Sonic Filter indicator, therefore, it remains unlit, indicating that the Sub-Sonic filter circuit is not activated. With the output of IC102 (pin 1) low, FET's Q108 and Q109 in the Sub-Sonic filter circuits are allowed to conduct thereby keeping the circuits deactivated (for a more detailed description of the Sub-Sonic Filter circuitry, see "Sub-Sonic Filter Circuit").

By contacting the Sub-Sonic Filter touch-control, a bias network consisting of; R104, R105 and the resistance of the finger tip, is formed for Q102. The transistor becomes turned-on and current flow through the transistor allows a high potential (about 14 V) to be developed across R113. This high potential at the collector of Q102 is coupled through the de-bounce circuit consisting of; D102, R112, and C102, to the input of IC101 (pins 8 and 9). The de-bounce circuit is designed to keep the switching circuit from being activated twice when firm contact with the touch-control is not made. By "brushing" over the touch-



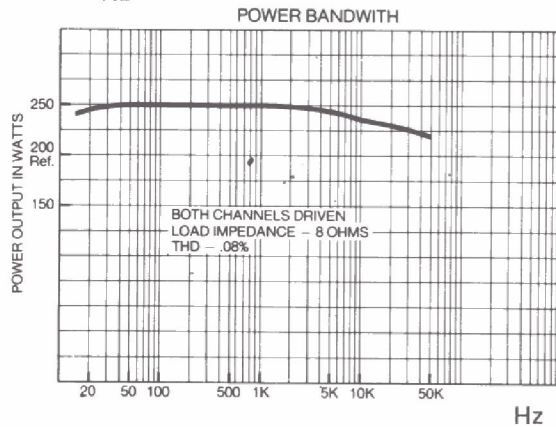
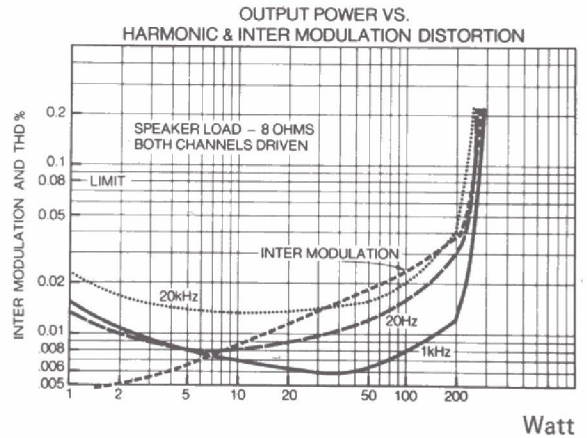
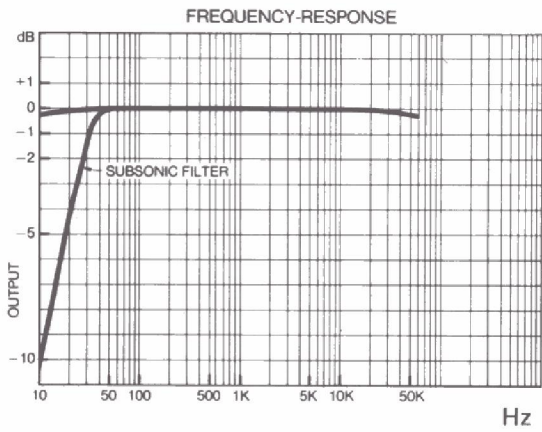
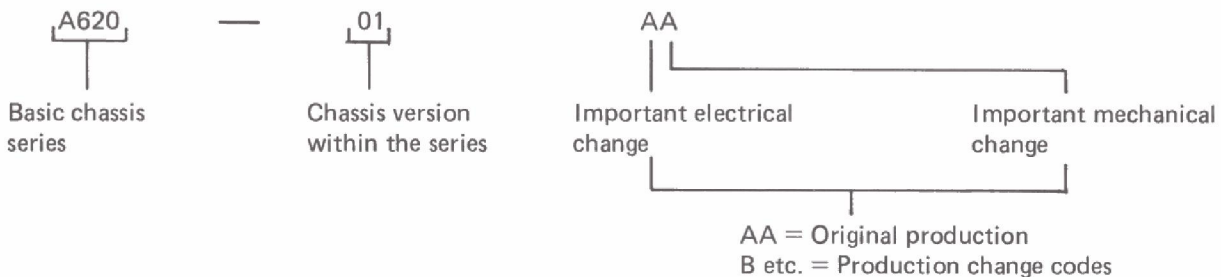

Fig. 3

**CHASSIS IDENTIFICATION**



**INSTRUCTIONS FOR SERVICING AND REPLACING PARTS**

**Driver and output transistor replacement**

Since transformerless quasi complementary output circuitry is utilized in this chassis, extreme care should be exercised when servicing or replacing the transistors. It is imperative that the transistors be isolated from the heat sink by means of a mica insulator coated on both sides with Dow-Corning DC4 silicon grease, or equivalent

When replacing a driver or output transistor, make certain the replacement transistor has the same beta range (i.e., Orange or Red) as the defective transistor. The beta range of the transistor is indicated by a red or orange dot (or lettering) on the top of the case. Failure to replace a defective driver or output transistor with one having the same beta characteristics could be detrimental to the performance of the power amplifier.

After servicing or replacing one or more of the output transistors, the Quiescent Current Adjustment must be performed in the affected channel. Misadjustment of the output transistors will cause crossover distortion and possible premature failure of the output transistors.

**Driver board assembly service position**

For ease in troubleshooting and servicing the components located on the driver board assembly, disassemble the chassis as follows:

1. Remove the cabinet top (1) and bottom pan from the power amplifier.
2. Remove the four safety screens from the large heat sink to which the driver board assembly, that is to be serviced, is mounted to.
3. To obtain additional slack for the wires connected to the thermal switch (mounted on the large heat sink), remove the wires from the nylon tie located on the bottom of the chassis.
4. Remove the eight screws securing the large heat sink to the chassis. The driver board assembly/heat sink can now be removed from the chassis by gently rocking it back and forth while, at the same time, lifting it up and out of the chassis. When the driver board assembly/heat sink is released from the chassis,

control, Q102 may be rapidly turned on and off several times. The "de-bounce" circuit integrates the rapid changes in the Q102 collector voltage caused by this condition, and applies a more constant potential to the input of IC101, causing it to change states only once.

When the inputs to IC101 go high (about 14 V), the output (pin 11) goes high (about 12 V). This high potential is directly coupled to the input (pin 3) of IC102, causing its output (pin 1) to change states. Since the output was low (near ground), it now becomes high and remains there until IC102 receives another high input. The high input (about 12 V) at pin 1 of IC102 drives Q105 into saturation placing its collector voltage near ground and forming a current path for the Sub-Sonic filter indicator, D3. With its anode tied to the +14.5 V source and its cathode tied to ground through R158 and Q105, the LED, D3, illuminates to indicate the Sub-Sonic filter circuit is now activated. The high output at pin 1 of IC102 is also applied to the gates of Q108 and Q109 in the Sub-Sonic filter circuit activating the Sub-Sonic filter circuitry (for a more detailed description of the Sub-Sonic Filter circuitry, see "Sub-Sonic Filter Circuit").

When the finger tip is removed from the touch-control, Q102 returns to cut-off, the input to IC101 (pins 8 and 9) returns to a low state, and the output of IC101 (pin 11) returns to its low state. Since the output of the flip-flops, IC102, changes states only when its input goes high, the new conditions will have no effect upon it. Therefore, pin 1 of IC102 will remain high keeping Q105 saturated and the Sub-Sonic filter circuits activated.

By contacting the touch control a second time, another high input is applied to IC102 reversing the state of its output to a low potential (near ground). This low potential at pin 1 of IC102 is applied to the gates of Q108 and Q109 in the Sub-Sonic filter circuit, de-activating the Sub-Sonic filter circuitry (for a more detailed description of the Sub-Sonic filter circuitry, see "Sub-Sonic Filter Circuit").

The low potential at pin 1 of IC102 is also felt at the base of Q105, causing it to cut-off. With Q105 cut-off, a current path for D3 no longer exists. The Sub-Sonic filter indicator, D3, therefore, stops conducting and extinguishes, indicating that the Sub-Sonic filter circuits are de-activated.

**Meter Range** — The two Meter Range touch-controls permit two ranges of peak power indication. The "0 dB" (X1) range reads peak power directly up to 200 watts, while the "20 dB" (X.01) range attenuates the meter indication 20 dB for a full scale deflection of 2 watts.

A difference exists in the operation of the Meter Range touch-controls. The "0 dB" and "20 dB" touch-controls work in conjunction with one another so as one touch-control is activated, the other touch-control is de-activated.

In this circuit Q103 and Q104 are the switches used to select the meter range (X1 or X.01) of the front panel peak power indicator meters. As with any switch, Q103 and Q104 are either open (cut-off) or closed (saturated). The purpose of the touch-control logic circuits is to make it possible to change the conduction of the switching transistors, Q103 and Q104, by means of a touch-control. The main components used to perform this function are: Q103 and Q104, which act as momentary switches; and IC103, a dual flip-flop which is externally connected so as one flip-flop is "set" the other flip-flop is "re-set".

The +12 V source is used by IC103 in this circuit to maintain the state of the logic when the unit is switched off, as explained in the Power Supply section. The +14.5 V source supplies power to Q103 and Q104. The flip-flops are connected so that the state of its output (high or low) is determined each time it receives a high input.

When the amplifier is turned on, one of the meter ranges will be activated as indicated by the illumination of the LED indicator located above the touch-control contacts. The meter range indicated will be the same meter range that was activated when the amplifier was switched off, as the logic circuits are kept activated (see "Power Supply"). For discussion purposes assume the "0 dB" (X1) meter range is activated, therefore, the "20 dB" (X.01) meter range is de-activated. When the "20 dB" (X.01) meter range is not activated, Q103 is turned off because of the open touch-control in its base circuit. The input to IC103 (pins 4 and 8) and output of IC103 (pin 13) are all low, near ground potential. The low output of IC103 (pin 13) keeps Q107 cut-off. With Q107 cut-off there is no current path for D1, the "20 dB" (X.01) meter range indicator, therefore, it remains unlit, indicating that the "20 dB" (X.01) meter range circuit is not activated.

When the output of IC103, pin 13 (X.01 meter range flip-flop), is low, pin 1 (X1 meter range flip-flop) is high. This condition exists because IC103 is externally connected so when the X1 meter range flip-flops output (pin 1) is high ("set" state), the X.01 meter range flip-flops output (pin 13) is low ("re-set" state), and vice-versa. This is accomplished by tying the X1 meter range flip-flops "set" input (pin 6) to the X.01 meter range flip-flops "re-set" input (pin 10), and the X1 meter range flip-flops "re-set" input (pin 4) to the X.01 meter range flip-flops "set" input (pin 8).

Therefore, the high output at pin 1 (X1 meter range flip-flop) of IC103 drives Q106 into saturation, placing its collector voltage near ground and forming a current path for the "0 dB" (X1) meter range indicator, D2.

With its anode tied to the +14.5 V source and its cathode tied to ground through R124 and Q106, the LED, D2, illuminates indicating the "0 dB" (X1) meter range is now activated. The near ground potential at the collector of Q106 is also applied to the gates of Q110 and Q111 in the meter range circuit. This action activates the "0 dB" (X1) meter range circuitry (for a more detailed description of this circuitry, see "Meter Range Circuit").

By contacting the "20 dB" (X.01) Meter Range touch-control, a bias network consisting of; R106, R107 and the resistance of the finger tip, is formed for Q103. The transistor becomes turned-on, and current flow through the transistor allows a high potential (about 14 V) to be developed across R114. This high potential at the collector of Q103 is coupled through R115 to the input of IC103 (pin 8, X.01 meter range flip-flop "set" input; and pin 4, X1 meter range flip-flop "re-set" input). This high potential causes the output of the X1 meter range flip-flop (pin 1) to go low (near ground potential) as the input at pin 4 causes it to "re-set" and Q106 cuts-off. With Q106 cut-off there is no current path for D2, the "0 dB" (X1) meter range indicator, therefore, it extinguishes, indicating the "0 dB" (X1) meter range circuit is not activated. With no current flowing through Q106, its collector voltage is near 12 volts. This voltage is applied to the gates of Q110 and Q111 in the meter



be careful not to damage the wires connected to the thermal switch.

5. The driver board assembly/heat sink can now be laid down along side the chassis.
6. Connect the extender cables between P201 and J201, and between P202 and J202. Power can now be applied to the chassis, when it is in the driver board assembly service position, for troubleshooting the circuitry contained on the driver board assembly. For extender cable fabrication instructions, see "Extender Cable Fabrication".
7. To reassemble, reverse the preceding steps.

#### Extender cable fabrication

A set (two cables) of extender cables must be fabricated to power the chassis when in the Driver Board assembly position. Fabrication of a single cable is as follows:

1. The materials required to fabricate a single extender cable are listed below:

Qty	Description
8	127 mm lengths of insulated 18 gauge solid wire
1	4822 265 30151, 8-pin male connector
1	4822 265 30155, 8-pin female connector

2. Prepare the eight lengths of wire by removing 6 mm of insulation from each end.
3. Tin the wire ends, as well as the connector terminals on the male and female connectors.
4. Using one of the prepared lengths of wire, connect pin 1 of the male connector to pin 1 of the female connector. Continue wiring the connectors in this manner until the remaining seven pins of each connector have been connected to one another.

#### Replacement of components secured to chassis by rivets

1. Bore out the rivets using a drill bit slightly larger in diameter than the rivet, see Figure. 4.
2. Punch out the remainder of the rivet with a nail set or prick punch.
3. Remove the defective components.
4. Install the new component by securing it with another rivet, or suitable screw and nut.

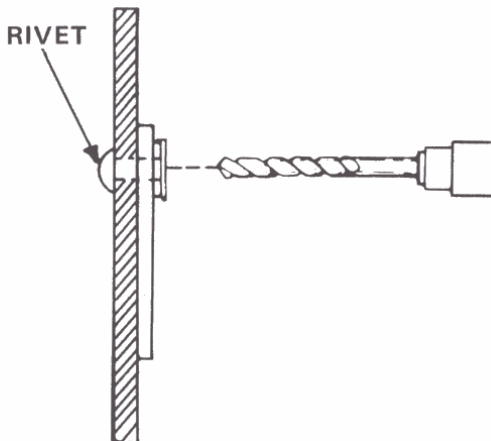

Fig. 4

## ADJUSTMENTS

### Quiescent current adjustment

To adjust the direct coupled quasi complementary output stage, perform the following adjustment on each Driver Board assembly:

1. Place the speaker switch to the "Off" position.
2. Rotate the level controls completely counterclockwise (no input signal).
3. Connect a DC VTVM across R234.
4. Adjust R220 (Idle Range) to read 45 mV,  $\pm$  5 mV, on the DC VTVM as soon as the amplifier is turned On (cold).

*Note: This adjustment must be performed in the affected channel when any of the output transistors are replaced. Misadjustment will cause crossover distortion and possible premature failure of the output transistor(s).*

### Level meter adjustment

To adjust the level meters perform the following adjustments, left channel and (right channel), on the front board assembly:

1. Disconnect J105 from P105.
2. With the "0 dB" (X1) meter range activated, couple a 200 mV, 1,000 Hz signal to pin 2 (1) of P105.
3. Connect an AC VTVM to the positive terminal of C119 (IC120), and adjust R140 (R141) until 105 mV is indicated on the meter.
4. Connect J105 to P105.
5. Connect an AC VTVM to the left (right) channel speaker system "A" terminals, and place the speaker switch in the "A" position.
6. Rotate the left (right) channel level control to mid-position. Apply a 1,000 Hz signal to the left (right) channel input jack and adjust the generator output until 40 VAC is indicated on the AC VTVM.
7. Adjust R152 (R146) until 0 dB is indicated on the power amplifiers left (right) channel level meter.



range circuit which activates the "20 dB" (X.01) meter range circuitry (for a more detailed description of this circuitry, see "Meter Range Circuit"). Simultaneously, the high potential applied to pin 4 (X1 meter range flip-flop "re-set" input) of IC103 is also applied to pin 8 (X.01 meter range flip-flop "set" input). This action causes the output of the X.01 meter range flip-flop (pin 13) to go high (about 12 V) as the input at pin 8 causes it to "set". This drives Q107 into saturation, placing its collector voltage near ground and forming a current path for the "20 dB" (X.01) meter range indicator D1. With its anode tied to the +14.5 V source and its cathode tied to ground through R125 and Q107, the LED D1 illuminates, indicating the "20 dB" (X.01) meter range circuitry is now activated.

When the finger-tip is removed from the "20 dB" (X.01) touch-control, Q103 returns to cut-off and the input at pin 4 (X1 meter range flip-flop "re-set" input) and pin 8 (X.01 meter range flip-flop "set" input) of IC103 returns to a low potential (near ground). Since the output (pins 1 and 13) of the flip-flops contained in IC103 is controlled only when their inputs (pins 4 and 8, and pins 6 and 10) go high the new conditions will have no effect upon it. Therefore, the output of the "0 dB" (X1) meter range flip-flop (pin 1 of IC103) will remain low (near ground potential), keeping Q106 cut-off and the "20 dB" (X.01) meter range circuits activated; while the output of the "20 dB" (X.01) meter range flip-flop (pin 13 of IC103) will remain high (about 12 V), keeping Q107 saturated and the "20 dB" (X.01) meter range indicator, D1, illuminated.

Contacting the "20 dB" (X.01) touch-control a second or third time will have no effect upon the meter range circuitry, as the input to IC103 (pins 4 and 8) will keep the "0 dB" (X1) meter range flip-flop in the "re-set" (low output) state, and the "20 dB" (X.01) meter range flip-flop in the "set" (high output) state. Therefore, the output of IC103 (pins 1 and 13) will remain unchanged, even with repeated activation of the "20 dB" (X.01) touch-control. However, if the "0 dB" (X1) touch-control is activated, the potential developed at the collector of Q104 is applied to the input of IC103 (pin 6, X1 meter range flip-flop "set" input; and pin 10, X.01 meter range flip-flop "re-set" input). The application of this potential to the input of IC103 causes the output of the X.01 meter range flip-flop (pin 13) to go to the "re-set" (low output) state, and the output of the X1 meter range flip-flop (pin 1) to go to the "set" (high output) state. This action causes the "20 dB" (X.01) meter range indicator, D1, to stop illuminating and allows the "0 dB" (X1) meter range indicator, D2, to illuminate, while initiation of the "0 dB" (X1) meter range circuitry.

### Sub-Sonic Filter Circuit

The Sub-Sonic filter circuit is located on the Front Board assembly and, when activated, is designed to attenuate frequencies below 10 Hz by 12 dB/Octave. Even though these frequencies cannot be heard, they can be felt, and may cause distortion and possibly damage the speakers. Therefore, the Sub-Sonic filter should be activated at all times.

Since the left and right channel Sub-Sonic filter circuits are identical, only the left channel will be discussed. In this circuit Q108 represents the switch used to activate the Sub-Sonic filter by decreasing the capacitance in series with the input signal. As with any switch, Q108 is either

open (Off) or closed (On). The main components comprising the Sub-Sonic filter circuit are; Q108, which acts as a switch, and IC104, which functions as an active filter while amplifying the signal approximately 8 dB.

The Sub-Sonic filter circuitry is controlled by the potential present at the output of IC102 (Pin 1), located in the Touch Control Circuit (see the Touch Control Circuit description). When the Sub-Sonic filter touch-control is not activated, the output of IC102 (pin 1) will be low, near ground potential. This low potential is applied to the gate of Q108 and turns On (closes) the FET. The FET now provides a lower impedance path for the signal than does C109 and C111; therefore, the signal at the wiper of the Left Channel Input Level Control, R2, is coupled through pin 4 of P/J104, Q108, and C107 to the input of Op Amp IC104A (pin 5).

IC104 operates as an active filter and amplifies the signal approximately 8 dB. A portion of the signal at the output (pin 7) is fed back to the inverting input (pin 6) through R131, R135 and C113. This feedback network determines the gain and frequency characteristics of the Op Amp. A portion of the signal at the output (pin 7) is also fed back to the junction of C109 and C111 through R129. This feedback network alters the frequency characteristics of the active filter for frequencies below 20 Hz. The high input impedance of IC104 offers minimum loading of the incoming signal, while its low output impedance is needed to drive the audio amplifier circuit contained on the Driver Board assembly.

(For a more detailed description of the Audio Amplifier Circuit, see "Driver Board Assembly").

When the Sub-Sonic filter touch-control is activated, the output of IC102 (Pin 1) rises to a high potential (about 12 V). This high potential is applied to the gate of Q108 and turns the FET off (open). This action places C109 and C111 into the circuit as the shunting effect of Q108 across the capacitors is removed. Under these conditions, the signal at the wiper of the Left Input Control, R2, is coupled through pin 4 of P/J104, C109 and C111 to the input of the Op Amp (pin 5 of IC104A). The Op Amp amplifies the signal as previously described, however, the signal applied to the input will be altered by the capacitive reactance introduced into the circuit by C109 and C111 as well as the feedback applied to the junction of these two capacitors. The reactance of C109 and C111 is very low for the higher frequencies (above 20 Hz) and has no effect on them, however, the reactance of C109 and C111 for low frequencies (below 20 Hz) is somewhat higher, resulting in attenuation of frequencies below 10 Hz by 12 dB/octave.

### Driver Board Assembly

The Driver Board assembly receives and amplifies the input signals to the unit. The input circuits are designed with a high input impedance and a low output impedance. This prevents loading of the source and helps eliminate hum and noise.

The direct coupled quasi complementary audio amplifier circuitry, excluding the driver and output transistors, is contained on a pair of identical Driver Board assemblies. One is used for the right channel while the other is used for the left channel. The pair of large heatsinks house the left and right channel drivers and the output transistors.

Because both channels are identical in operation, only the left channel circuitry will be discussed. The signal from the input jack (J1) is coupled through pin 4 of P/J104 and

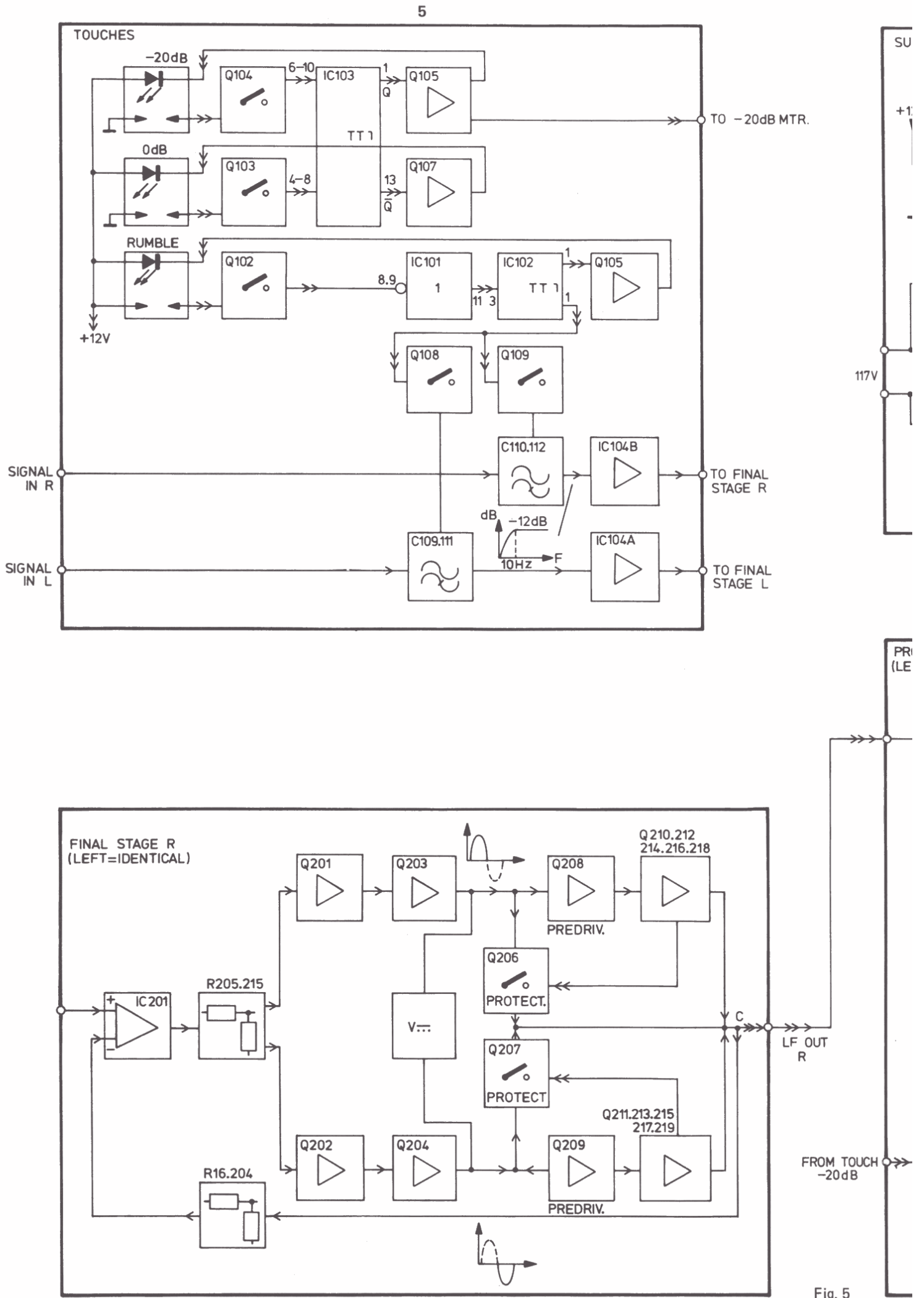

Fig. 5



applied to the Sub-Sonic filter. (For a more detailed description of the Sub-Sonic filter circuitry, see "Sub-Sonic Filter"). After the signal has been processed by the Sub-Sonic filter it is coupled through pin 2 of P/J104 and applied to the input of the Driver Board assembly, pin 8 of P/J201.

The audio signal present at pin 8 of P/J201 is applied through C201, R202, and R203 to the inverting input at pin 2 of the wideband amplifier, IC201. C201 removes the DC component, if present, from the audio signal, while R202 and C202 comprise an RFI trap which removes any RF interference that may be present at the input of IC201.

The +15 V supply at pin 7 of IC201 is derived from the +78 V source which is applied through R209, regulated by D201 and filtered by C206. Likewise, the -15 V supply at pin 4 of IC201 is derived from the -78 V source which is applied through R210, regulated by D202 and filtered by C207.

The gain and frequency characteristics of the wideband amplifier are determined by three feedback networks. The signal present at the output (pin 6) is coupled back through C204 to the inverting input at pin 2 for frequency compensation. The gain and frequency characteristics of the wideband amplifier are also determined by the signal coupled back through the divider network comprised of R216, C210, R204 and C203 to the non-inverting input at pin 3. C205 offers phase compensation for the wideband amplifier.

The output of the wideband amplifier (pin 6 of IC201) is coupled through R205 to the junction of R212, R213 and R215 and applied to the emitters of Q201 and Q202 through R212 and R213. Q201 and Q202 amplify the audio signal which is direct-coupled to the bases of Q203 and Q204. Since Q201 and Q202 are connected in a common base configuration, the signal at the collector is in phase with the input signal applied to the emitter. D203, D204 and R207 provide proper biasing for Q201 and Q202 to operate class A.

Q203 and Q204 are biased for class A operation and further amplify the audio signal. Q203 and Q204 are connected in a common emitter configuration, therefore, the signal is inverted at the collectors. The output of Q203 and Q204 is applied to the bases of the pre-drivers, Q208 and Q209 which are biased for class AB operation.

The signal at the output of the pre-drivers must be as near 180 degrees out-of-phase and equal in amplitude as possible at all audio frequencies for application to the driver and output transistors. Therefore, Q208 is connected as an emitter follower and the signal has no phase reversal. Q209 is connected as a common emitter amplifier and amplifies the signal with a 180 degree phase reversal.

The Idle Range potentiometer, R220, and associated circuitry (Q205 and D205) controls the quiescent current of the amplifier section by controlling the conduction of Q205.

The three output transistors and their associated drivers for each channel operate in a push-pull configuration. Crossover distortion is eliminated by D210, D211, D203, D204, and the action of the driver transistor being slightly forward biased by the current flow through its base circuit

Each driver/output transistor combination has an associated protective circuit. The protection circuit

functions to reduce the forward bias and, therefore, reduce the current through the driver transistor in the event of excessive current flow through the associated output transistors.

When current through resistor R236 is low, the current through the base bias divider network comprised of R225, R226, and D208 is insufficient to forward bias Q206 into conduction, and, therefore, Q206 appears as an open circuit. However, if the current from a positive-going signal through the output transistors exceeds a safe level, the current through the base bias divider network for Q206 will be sufficient to cause Q206 to begin to conduct. D208 is used for temperature compensation, while R227 limits the safe operating area of Q206 at high voltage levels. When Q206 conducts, it provides a shunt path for the base emitter junction of pre-driver transistor Q208, reducing the forward current through the base-emitter junction, and therefore reducing the conduction of Q208. D206 is used to prevent reverse current flow. In this manner the current through the output transistors is limited to provide safe operation. Q207 and its associated circuitry act in a like manner to protect during the negative-going signals.

The output of the audio amplifier is applied to the speakers through P/J202, P/J302, and S1. High frequency compensation, as well as square wave response of the output signal, is determined by the network comprised of R244, L201, R245 and C220. C218 and C219 are AC bypass capacitors that remove any AC components that may be present on the DC supply line.

### Protection Board Assembly

The protection circuit is located on the Protection Board assembly, and when activated, will protect the speakers connected to the amplifier from adverse operation conditions.

Since the left and right channel protection circuits are identical, only the left channel will be discussed. In this circuit, the normally open contacts of output relay K302 are used to disconnect the speaker from the audio amplifier circuit. Under normal operating conditions, the output relay is energized and the closed contacts allow the audio output signal to be applied to the speaker. However, under adverse operating conditions, the sensing action of the protection circuit is designed to open the contacts of K302 and disconnect the speakers from the audio output circuitry. Certain fault conditions will simultaneously close the contacts of the shunting relay, K303, placing a ground on the audio output circuits momentarily. Q302 and Q304 are used to sense abnormal positive or negative DC reference levels at the output of the audio amplifier, while Q306 and Q308 comprise a darlington switch used to provide a ground to the windings of output relay K302. The illumination of the "protection" indicator lamp, DS103, is controlled by the darlington switch comprised of Q314 and Q316, while Q310 and Q312 control the illumination of the "hot", indicator lamp, DS104. Thermal switch S2 is mounted external to the Protection Board assembly and is used to sense overheating of the output transistors. The +14.5 V source present at Pin 1 of P/J303 is applied to the base of Q310 via R308 and also supplies power to output relay K302 so it will be ready to energize. Q319 is used to provide ground to the windings of shunting relay K303.

When the unit is switched On, the voltage present at pin 4 of P/J304 (about 12 V) is applied to C303 through R316.



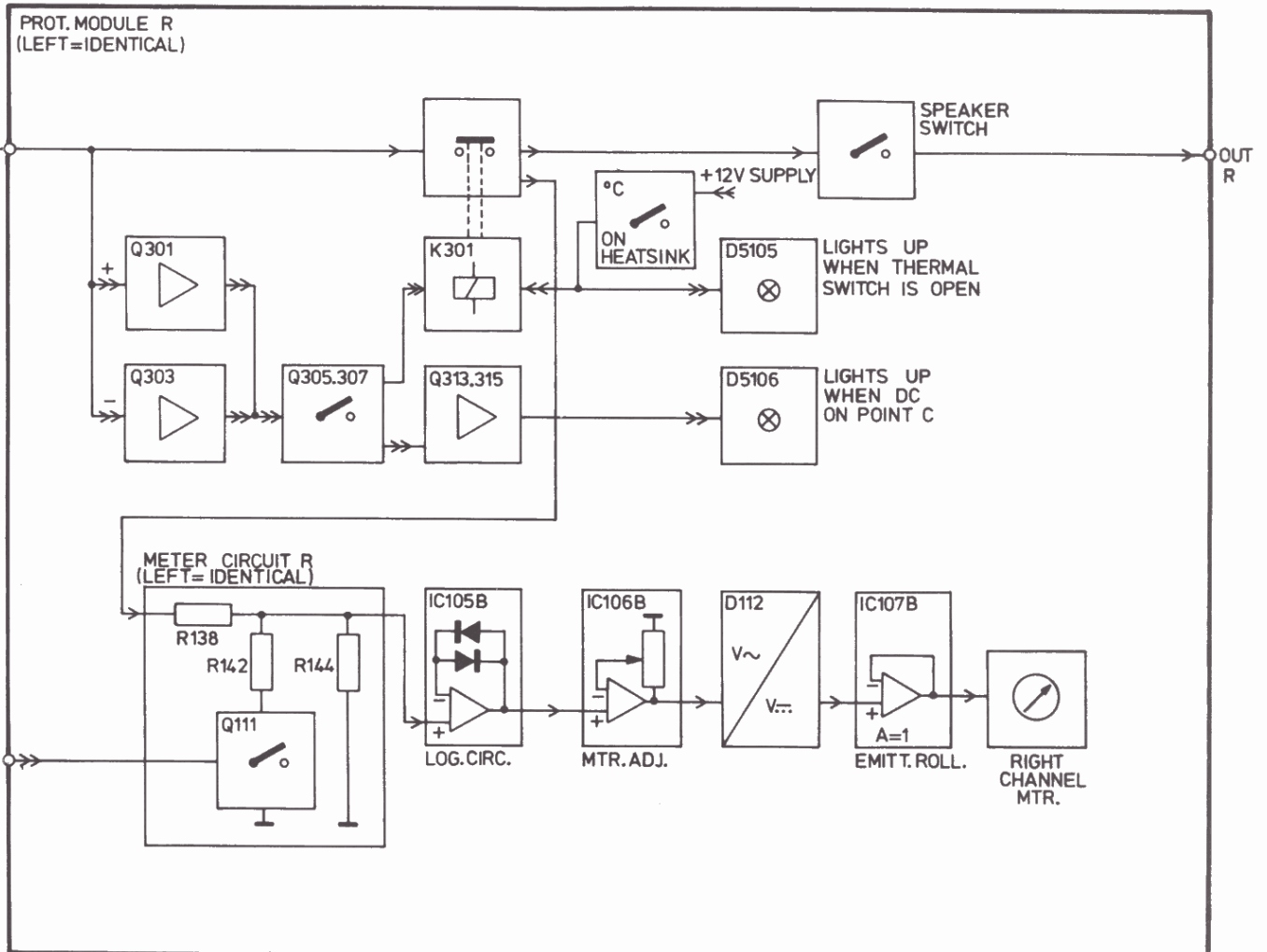
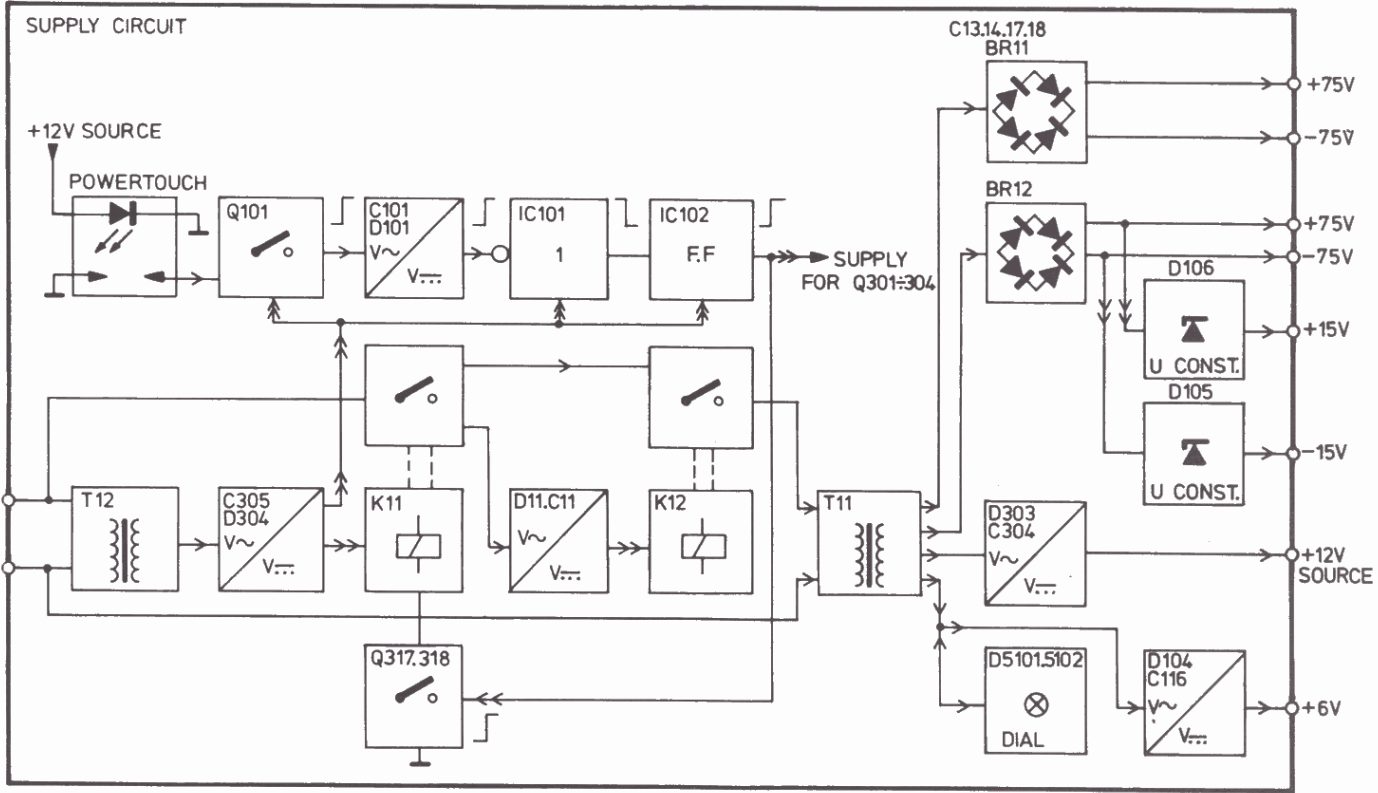

Fig. 5

This voltage charges C303 through R316 as D106 is reverse biased, and remains reverse biased as C303 charges to about 8 V. The charging time of C303 (approximately 2 seconds) is controlled by the RC time constant of R316 and C303. The DC potential developed at C303 is applied to the base of Q306 through R306. Q306 and Q308 form a darlington switch used to energize the output relay, K302. As with any switch, Q306 and Q308 are either open (cut-off) or closed (saturated). When C303 charges to a sufficient level (approximately 8 volts), it forward biases the emitter-base junction of Q306. This action allows Q306 and Q308 to saturate (close), dropping their collector voltages toward ground. A current path for make-contact output relay K302 now exists and it energizes. However, when the amplifier is switched On, Q306 and Q308 will be cut-off (open) for a short duration of time (approximately 2 seconds) while C303 charges to the potential required to forward bias Q306. During this short period of time Q306 and Q308 are cut-off and the collector voltage of Q308 is high (about 14 V).

This potential is applied through R310 to another darlington switch, Q314 and Q316. Q314 and Q316 control the illumination of the "protection" indicator lamp, DS103. The darlington switch saturates (closes), and Q316 collector voltage goes to near ground potential forming a current path for DS103. With one side of the lamp connected to the +8 V source, and the other side connected to ground through Q316, DS103 illuminates. While the illumination of "protection" indicator lamp DS103 normally would indicate a problem in the left channel audio amplifier circuit, in this situation it is a false indication as darlington switch Q306 and Q308 is cut-off not as a result of a malfunction in the audio amplifier, but because C303 has not yet charged to the voltage required to forward bias Q306.

As soon as C303 charges to the potential required to forward bias Q306; Q308 saturates (closes), and its collector voltage goes toward ground potential. Q310 and Q312 now cut-off (open). A current path for DS103 no longer exists and the "protection" indicator lamp extinguishes. This action is normal, and indicates that the "protection" indicator lamp and circuitry are functioning properly.

During the brief interval when darlington switch Q306 and Q308 is cut-off, its collector voltage (about 14 V) is also applied to the base of Q319 through D308, C307, and R317.

This would normally forward bias Q319 and allow the shunting relay, K303, to energize. However, the discharging of C306 will keep Q319 cut-off (open). When the amplifier is not switched on, the +30 volts present at the collector of Q318 charges C306. Then, when the amplifier is switched on, Q318 saturates (closes), and its collector voltage goes toward ground potential. This applies ground to the positive terminal of C306. C306 discharges through Q318, ground, D309, and R317 to the negative terminal of C306. While C306 discharges, a negative potential is coupled through R317 to the base of Q319, and Q319 remains cut-off. The discharge time of C306 is longer in duration than the charge time of C307, therefore, the discharging of C306 will offset the positive voltage coupled through C307 until C307 charges. When C307 becomes charged, current will no longer flow through it, and a negative potential will be developed at its negative terminal which will keep Q319 cut-off.

When C303 charges to the potential required to forward bias Q306, Q306 and Q308 saturate (close) dropping their collector voltage toward ground. C307 now discharges

through D308, ground, D309 and R317. While C307 discharges, Q319 will stay cut-off as a negative voltage is developed by C307 and applied through R317 to the base of Q319. After C307 discharges, Q319 will remain cut-off, since there is no source of forward bias.

When output relay K302 energizes, it closes its normally open contacts and allows the audio signal to be applied to the speaker. Since the output relay energizes a few moments (approximately 2 seconds) after the amplifier is switched on, "turn-on" noise is eliminated as the audio circuits will have already stabilized when the contacts of the output relay close.

Under normal operating conditions, Q302 and Q304 are cut-off, as the normal DC reference level at the output of the audio amplifier is 0 V.

The DC reference level at the output of the audio amplifier is constantly applied to the divider circuit consisting of R302 and R304. Any potential which may be developed at the junction of R302 and R304 is then applied to the base of Q302 and the emitter of Q304. C302 acts as an AC shunt to ground which removes the AC component from the potential applied to Q302 and Q304. If the AC components were not removed, it could cause both Q302 and Q304 to saturate (close) even though a normal DC reference level is present at the output.

When an excessive DC reference level (approximately 1 volt or greater) appears at the output of the audio amplifier, a DC potential will be developed by the divider circuit at the junction of R302 and R304 which is applied to Q302 and Q304 simultaneously. The potential applied to Q302 and Q304 can be positive or negative, depending upon the polarity of the DC reference level with respect to ground. When the DC potential developed by the divider network (R302 and R304) is of sufficient amplitude, Q302 or Q304, depending on its polarity, will saturate (close). This will remove the voltage potential (about 8 V) on C303 as it discharges toward ground through R306 and either Q302 or Q304. The darlington switch (Q306 and Q308) now cuts-off (opens) and removes the ground provided for the output relay (K302). K302 de-energizes and its contacts open, disconnecting the speaker from the audio amplifier circuit. When Q306 and Q308 cut-off (open) their collector voltage goes high (about 14 V). This voltage is applied through R310 to the base of Q314. Q314 and Q316 form a darlington switch that controls the illumination of the "protection" indicator lamp, DS103. The voltage applied to the base of Q314 is of sufficient amplitude to cause Q314 and Q316 to saturate (close). With Q314 and Q316 saturated, their collector voltage drops towards ground, providing a current path for "protection" indicator lamp DS103. With one side of the lamp connected to the +8 V source and the other side connected to ground through Q316, DS103 illuminates, indicating there is a malfunction in the left channel audio amplifier. Simultaneously, the voltage present at the collector of Q308 (about 14 V) is also applied to the base of Q319 through D308, C307, and R317. This action forward biases Q319, and its collector voltage drops toward ground potential. The shunting relay K303 energizes and closes its normally open contacts, grounding the output of the audio amplifier. Because C306 is discharged, it will not offset the positive voltage applied to the base of Q319, as previously described. When C307 becomes charged, current will no longer flow through it and a negative potential will be developed



at its negative terminal which will cut-off (open) Q319. With Q319 cut-off, the current path no longer exists for shunting relay K303, and it de-energizes. This action removes the ground which was applied to the output of the audio amplifier when output relay K302 de-energized to disconnect the speaker from the left channel audio amplifier. Normal operation can be restored by switching the amplifier off, and after a few seconds, turning it back on. Should the protection circuit activate again, indicated by DS103, a malfunction exists in the audio amplifier and must be corrected.

Thermal protection is accomplished with a heat sensitive switch mounted to the heat sink, housing the output transistors. The operating temperature of the output transistors is transferred to the heatsink from the output transistors and is applied to the thermal switch S2. If the output transistors should overheat, the thermal switch will sense the excessive operating temperature and open its normally closed contacts.

When thermal switch S2 contacts open, the +14.5 V source applied to pin 1 of P/J303 is removed, as the thermal switch is in series with the source. Output relay K302 now deenergizes as there is no longer a power source for it, and its contacts open. This disconnects the speaker from the audio amplifier. Simultaneously, the base of Q310 goes low, as the +14.5 V source is no longer applied to pin 1 of P/J303. Q310 saturates, and current flow through the transistor allows a high potential (about 14 V) to be developed across R314. This high potential at the collector of Q310 is coupled through R312 and applied to the base of Q312. Q312 saturates (closes) and its collector voltage goes toward ground, forming a current path for "hot" indicator lamp DS104. With one side of the lamp connected to the +8 V source and the other side connected to ground through Q312, DS104 illuminates, indicating the output transistors have overheated. After the output transistors have cooled (approximately 15 to 20 minutes) the thermal switch contacts will close, resetting the circuit. When the "hot" circuit resets, the +14.5 V source once again supplies power to the output relay, K302. The output relay energizes, closing its normally open contacts, and connecting the speaker to the output of the audio amplifier. The bias on Q306 and Q308 is not effected when the "hot" protection circuit is activated, therefore, the darlington switch remains saturated (closed) and provides a ground for output relay K302. This allows the output relay to energize when the thermal switch resets and applies power to the relay.

When thermal switch S2 resets, the +14.5 V source is also applied through pin 1 of P/J303 and R308 to Q310 base. Q310 cuts-off and its collector voltage goes low, near ground potential. This low potential is also applied to the base of Q312, causing it to cut-off (open). With Q312 cut-off, a current path for DS104 no longer exists. The "hot" indicator lamp, DS104, stops conducting and extinguishes indicating that the "hot" sensing circuit is no longer activated.

When the amplifier is switched off, the voltage present at pin 4 of P/J304 drops to ground potential. This forward biases D306 and effectively shorts R316. With R316 shorted, the RC time constant between C303 and R316 is very low. C303 discharges quickly, therefore darlington switch Q306 and Q308 cuts-off immediately when the off function is initiated. With Q306 and Q308 cut-off a current path for output relay K302 no longer exists and it de-energizes, opening its contacts and disconnecting the

speaker from the output of the audio amplifier. Simultaneously, the high potential (about 14 V) present at the collector of Q308 is applied to the base of Q319 through D308, C307, and R317. This turns on Q319. With Q319 saturated, a ground is provided for the shunting relay, K303. When the shunting relay energizes, its normally open contacts close and ground the output of the audio amplifier.

K303 will stay energized until C307 fully charges. When C307 is fully charged, no current will flow through it, therefore, the high potential present at the collector of Q308 is no longer applied to the base of Q319. However, the charge developed on the negative terminal of C307 is applied to the base of Q319. Q319 cuts-off (opens) and removes the ground applied to shunting relay K303. With Q319 cut-off, a current path for the output relay no longer exists and it de-energizes, opening its contacts and removing the ground applied to the output of the audio amplifier. When the amplifier is switched off, the high potential at the collector of Q108 is also applied through R310 to the darlington switch comprised of Q314 and Q316. This action will cause the "protection" indicator lamp, DS103, to illuminate for a very short period of time while the amplifier turns Off. The brief illumination of DS103 during turn off is normal. When the amplifier is switched off, C307 discharges and Q319 will remain cut-off (open) as no forward bias will be developed for the emitter base junction. The operation of the protection circuitry when the amplifier is switched off prevents any "turn-off" noises from reaching the speaker.

### Meter Range Circuit

The Meter Range circuit is located on the Front Board assembly and permits two ranges of peak power indication. The "0 dB" (X1) range allows peak power indication up to 200 watts, while the "20 dB" (X.01) range indicates peak power up to 2 watts. The "20 dB" (X.01) range will provide more accurate peak power readings when the listening level is 2 watts or less.







Since the left and right channel meter range circuits are identical, only the left channel will be discussed. In this circuit Q110 is the switch used to select the desired meter range, "0 dB" (X1) or "20 dB" (X.01), by changing the resistance of the input divider network. As with any switch, Q110 is either open (off) or closed (on). The main components comprising the meter range circuit are: Q110, IC105, which functions as a logarithmic amplifier; IC106, which functions as a linear amplifier; D111, C121, and R154, which comprise a "sample and hold" circuit; and IC107, which functions as a linear amplifier.

The Meter Range circuitry is controlled by the potential present at the collector of Q106, located in the touch-control circuit. (For a more detailed description of the Meter Range touch-control logic circuits, see "Touch Control Circuit"). When the "20 dB" (X.01) meter range touch control is activated, Q106 is cut-off and its collector voltage is high (about 12 V). This high potential is applied through R143 to the gate of Q110 and turns the FET off (open). To prevent false triggering of Q110, C118 is connected from its gate to ground, providing an AC shunt. With Q110 off, the input divider network consists of R138, and R144, with R142 effectively removed from the circuit when Q110 is biased off (open). However, when the "0 dB" (X1) meter range touch-control is activated, Q106 saturates, and its collector voltage drops toward ground potential. This low potential is applied through R143 to the gate of Q110 and turns the FET on





## DRIVER BOARD

4822 214 50193

<b>-IC-</b>		
201		4822 209 80461
		
Q201	213N1	4822 130 41254
Q202	360P1	4822 130 41256
Q203-204	383P1/383N2 pair	4822 130 41248
Q205	263N6	4822 130 41255
Q206	148N3	4822 130 41186
Q207	158P3	4822 130 41253
Q208-209	357N2/357P1 pair	4822 130 41247
		
D201-202	Zener 15 V - 1/2 W	4822 130 31045
D203...205		4822 130 31064
D206...209		4822 130 31063
D210-211	1A - 200 V	4822 130 31062
		
L201	3 $\mu$ H	4822 157 40154
		
C201	100 $\mu$ F - 25 V	4822 124 20587
C203	470 $\mu$ F - 25 V	4822 124 20533
C206-207	4.7 $\mu$ F - 50 V	4822 124 20824
		
C204	10 pF-10 %-500 V	4822 122 31195
C205	33 pF-10 %-500 V	4822 122 31202
C208-209	22 pF-10 %-500 V	4822 122 31199
C216	0.47 $\mu$ F-10 %-500 V	4822 121 40015
C218...220	1 $\mu$ F-10 %-100 V	4822 121 40447
		
R204	220 $\Omega$ -2 %-1/4 W	5322 116 54002
R209-210	3K3 - 5 %-8 W	4822 115 40128
R216	3K9 - 2 %-1/2 W	5322 116 55019
R226-229	1K - 10 %-2 W	4822 116 60055
R230-232	100 $\Omega$ -5 %-1/2 W	4822 110 43081
R231	10 $\Omega$ -5 %-1/2 W	4822 110 43054
R233-235	10 $\Omega$ -10 %-2 W	4822 111 70121
R234	0.18 $\Omega$ -10 %-10 W	4822 113 80219
R236...241	0.47 $\Omega$ -10 %- 3 W	4822 113 80221
R244	10 $\Omega$ -10 %-2 W	5322 116 54348
R245	33 $\Omega$ -10 %-5 W	4822 113 80217
		
R220	220 $\Omega$ - 30 %	4822 101 10233

## PROTECTION BOARD

4822 214 50192

		
Q301...308	232N2	4822 130 41101
311...319		
Q309-310	83P1	4822 130 41252
		
D301-302		4822 130 30998
306...310		
D303...305		4822 130 31047
		
C301-302	47 $\mu$ F-16 V	4822 124 20699
C303-306	2.2 $\mu$ F-50 V	4822 124 20724
C304	1000 $\mu$ F-16 V	4822 124 20524
C305	470 $\mu$ F-35 V	4822 124 40163
C307	10 $\mu$ F-35 V	5322 124 24094
<b>-Miscellaneous-</b>		
K301-302		4822 280 70159
K303		4822 280 70161



## TOUCH CONTROL BOARD



4822 214 50194

		
D1...4		4822 130 30999



## FRONT BOARD







4822 214 50191

<b>-IC-</b>		
101	IC612119 RCA652	4822 209 80399
102-103	IC612074-1 CD4013	4822 209 10002
	BCN	
104...107		4822 209 80459
		
Q101...104	356P1	4822 130 41191
Q105...107	232N2	4822 130 41101
Q108...111	234P1	4822 130 41189
		
D101-102		4822 130 30998
D103	Zener 12 V - 1/2 W	4822 130 34197
D104		4822 130 31047
D105-106	Zener 15 V - 1/2 W	4822 130 31045
D107...112		4822 130 31064
		
C101-102-104	1 $\mu$ F - 50 V	4822 124 20822
C103	100 $\mu$ F - 25 V	4822 124 20567

C107-108- 119-120- 123-124	22 $\mu$ F - 10 V	4822 124 20459
C115-117	220 $\mu$ F - 25 V	4822 124 20526
C116	470 $\mu$ F - 16 V	4822 124 40162
C125-126	47 $\mu$ F - 10 V	4822 124 20678
		
C109...112	560 nF-10 %-250 V	4822 121 40044
C113-114	18 pF- 5 %-500 V	4822 122 31198
C121-122	220 nF-20 %-100 V	4822 121 40515
		
R140-141	1 k $\Omega$	4822 100 10245
R146-152	47 k $\Omega$	4822 101 10234
<b>-Miscellaneous-</b>		
DS101-102		4822 134 40367
DS103...106	GE1302	4822 134 40354

## BASIC CHASSIS

		
Q210...217	355N1 Red dot	4822 130 41249
Q210...217	355N1 Orange dot	4822 130 41251
		
BR11-12		4822 130 31066
D11	1A	4822 130 31047

		
T11		4822 146 40244
T12		4822 145 30206
		
C11.17...20	50 $\mu$ F-150 V	4822 124 20312
C13...16	15000 $\mu$ F-85 V	4822 124 70269
		
C12-21-22	0.01 $\mu$ F-20 %-1400 V	4822 122 40128
		
R11	560 $\Omega$ - 10 %-2 W	4822 116 51154
R12	1 $\Omega$ - 10 %-22 W	4822 113 80222
R13...16	3K3 - 10 %-7 W	4822 113 80218
		
R2-3	50K - 1/8 W	4822 103 20518
		
S1		4822 273 60109
S2-3		4822 271 30194
S11		4822 277 10426
<b>-Miscellaneous-</b>		
K11		4822 280 70162
K12		4822 280 70163



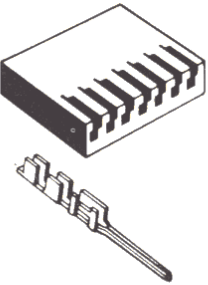

3 Pin	4822 267 40294
4 Pin	4822 267 40295
5 Pin	4822 267 40296

4822 268 10118

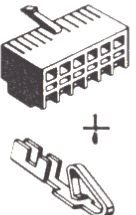

3 Pin	4822 267 40317
4 Pin	4822 267 40297
5 Pin	4822 267 40298
6 Pin	4822 267 50248
9 Pin	4822 267 50249
10 Pin	4822 267 50264

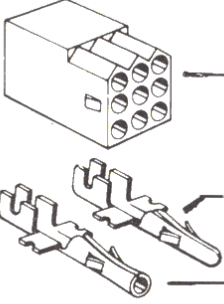

4822 267 50243	
φ 2.2 mm	4822 268 10114
φ 3 mm	4822 268 10121
φ 2.2 mm	4822 268 20071
φ 3 mm	4822 268 20073

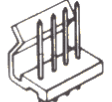

2 Pin	4822 265 30152
4 Pin	4822 265 30136
9 Pin	4822 265 30153



4822 268 10115



8 Pin	4822 265 30155
-------	----------------

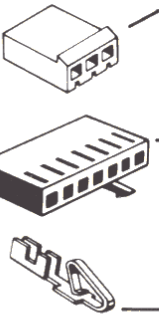

2 Pin	4822 267 50269
4 Pin	4822 167 40271
3 Pin	4822 267 40272
4 Pin	4822 267 40273
5 Pin	4822 267 40274
6 Pin	4822 267 50244
7 Pin	4822 267 50245
9 Pin	4822 267 50246

4822 268 10113

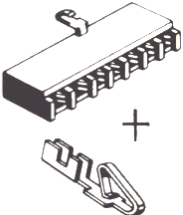

3 Pin	4822 267 40291
4 Pin	4822 267 40292
5 Pin	4822 267 40293
6 Pin	4822 267 50247
7 Pin	4822 265 30154
8 Pin	4822 267 50263

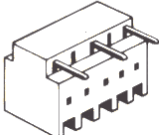

3 Pin	4822 267 40275
4 Pin	4822 267 40276
5 Pin	4822 267 40289

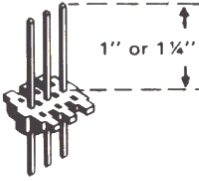

3 Pin, 1"	4822 265 40137
3 Pin, 1 1/4"	4822 265 30141
4 Pin, 1"	4822 265 30138
5 Pin, 1"	4822 265 30139
5 Pin, 1 1/4"	4822 265 30142
6 Pin, 1"	4822 265 40128
6 Pin, 1 1/4"	4822 265 40136
7 Pin, 1"	4822 265 30156
8 Pin, 1/2"	4822 265 30151
8 Pin, 1"	4822 265 40135



3/4"	4822 268 10116
5/8"	4822 268 10117

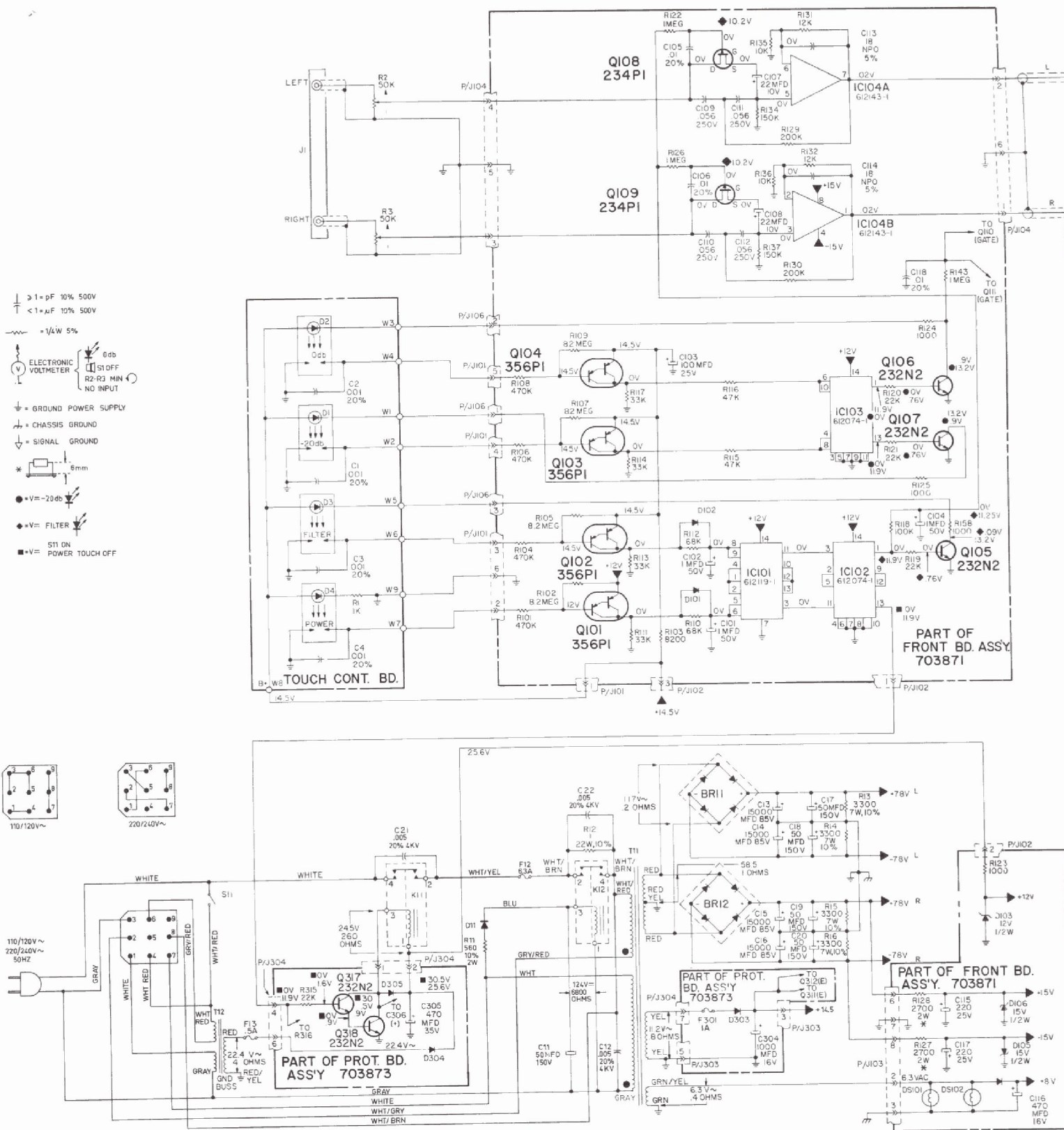

(closed). This action shunts R144 with R142. Therefore, when the "0 dB" (X1) meter range touch-control is activated (Q110 on), the input divider network consists of R138, R144 and R142 as R142 is effectively placed into the circuit when Q110 is biased on (closed), and the input to IC105 decreases to 1/10, or -20 dB.

The output of the audio amplifier is coupled through P/J302 and applied directly to the speaker switch (S1). Simultaneously, the output signal is also applied to the meter range circuit at pin 2 of P/J105, where it is coupled through the input divider network and applied to the in-

put of IC105 (pin 3).

IC105 operates as a logarithmic amplifier, the output of which is a logarithmic (as opposed to linear) function of its input. The gain characteristics of the logarithmic amplifier (IC105) are determined by a DC feedback network as well as two AC feedback networks. The signal present at the output (pin 1) is coupled back to the inverting input (pin 2) through R163 for DC feedback. The two AC feedback networks are somewhat more complex because the amplitude of the AC signal at the output of IC105 (pin 1) determines which one of the two AC feedback networks are used. When low amplitude AC signals



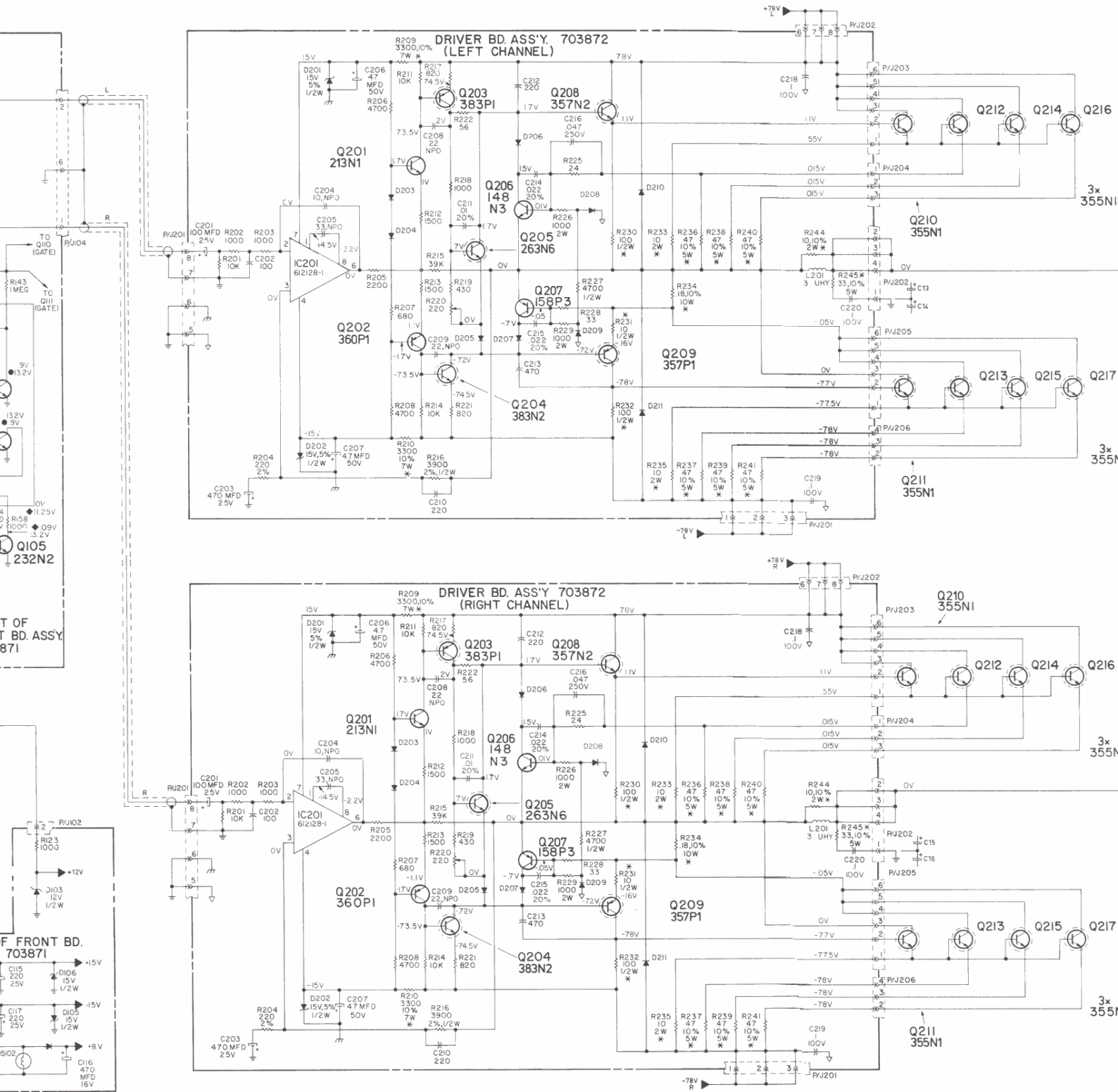

Fig. 1

appear at the output of the logarithmic amplifier (pin 1 of IC105), D107 and D108 are cut-off. Therefore, the signal is coupled back to the inverting input (pin 2) through the voltage divider consisting of R163, C126, and R140, forming the low AC feedback network. As the amplitude of the AC signal present at the output (pin 1) increases, D107 or D108 begin to conduct. Therefore, when high amplitude AC signals appear at the output of the logarithmic amplifier, they are coupled back to the inverting input (pin 2) through the voltage divider comprised of D107 or D108, C125, C126 and R140, forming

the high AC feedback network.

The output of the logarithmic amplifier is applied through C119 to the input of IC106 (pin 3) where it receives approximately 20 dB of amplification. R150 offers DC stabilization for the input of IC106. The +15 V source is applied through R161 to the junction of R151 and R152. This causes a slightly positive DC potential to be applied from the wiper of R152 to the inverting input (pin 2), keeping the output reference level of the amplifier (pin 1, IC106) slightly negative under no signal conditions. This action reverse biases D111 under "no signal" conditions.

out of  
ion of  
thmic  
k net-  
signal  
inver-  
k. The  
mplex  
put of  
feed-  
signals

The  
netw  
appli  
The  
D111  
prese  
circu  
appli  
the l  
design  
disch

- 1 4822 426 40152
- 2 4822 426 60141
- 3 4822 535 91106
- 4 4822 256 90245
- 5 4822 255 20084
- 6 4822 426 90054
- 7 4822 426 50305
- 8 4822 454 10614
- 9 4822 404 20249
- 10 4822 535 80611
- 11 4822 535 80609
- 12 4822 255 40149
- 13 4822 273 60109
- 14 4822 256 30163
- 15 4822 395 50132
- 16 4822 347 20088
- 17 4822 413 30724
- 18 4822 413 50947
- 19 4822 462 40366
- 20 4822 266 30083
- 21 4822 267 40316
- 22 4822 325 50117
- 23 4822 146 40244
- 24 4822 277 10426
- 25 4822 395 90098
- 26 4822 256 40051
- 27 4822 256 90231
- 28 4822 500 10191
- 29 4822 502 30144
- 30 4822 500 30011
- 31 4822 502 30102
- 32 4822 502 11053
- 33 4822 502 30145
- 34 4822 130 30999
- 35 4822 276 10676

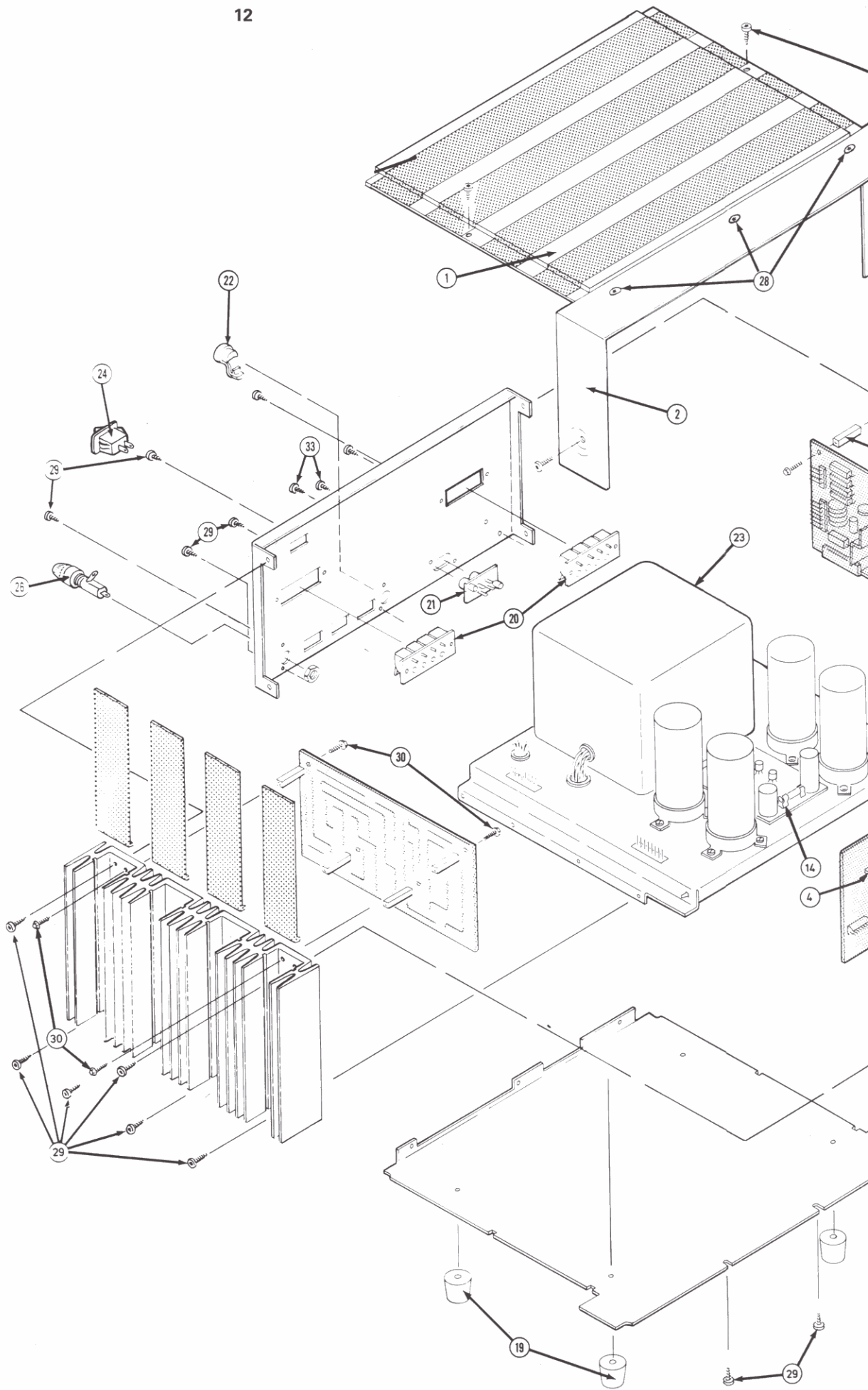

Fig. 8